

INDUSTRIAL TOOLS



TABLE OF CONTENTS

INTRODUCTION

- 4 About Holmatro
 - 8 Basic knowledge of hydraulics
-

HYDRAULIC CYLINDERS

- 12 Composing a hydraulic cylinder system
 - 13 Holmatro cylinders
 - 14 Selection list cylinders
 - 17 Multi purpose cylinders | spring return
 - 20 Flat cylinders | spring return
 - 22 Short stroke cylinders | spring return
 - 23 Aluminium cylinders | spring return
 - 25 Aluminium cylinders | hydraulic return
 - 27 High tonnage cylinders | gravity return
 - 29 High tonnage cylinders | hydraulic return
 - 31 Telescopic cylinders | gravity return
 - 32 Locknut cylinders | gravity return
 - 33 Locknut cylinders | hydraulic return
 - 35 Alum. hollow plunger cylinders | spring return
 - 37 Alum. hollow plunger cylinders | hydraulic return
 - 39 Hollow plunger cylinders | spring return
 - 41 Hollow plunger cylinders | hydraulic return
 - 42 Hollow plunger cylinders | gravity return
 - 43 Pulling cylinders | spring return
 - 44 Pulling cylinders | pulling eyes
 - 44 Pulling cylinders | clevis eyes
 - 44 Pulling cylinders | protection springs
 - 45 Machine lift | spring return
 - 45 Toe cylinder | spring return
 - 46 Multi purpose cylinders | set
 - 47 Multi purpose cylinders | set parts
 - 49 Accessories | 5 tons cylinder
 - 49 Accessories | 10 tons cylinder
 - 51 Accessories | 15 tons cylinder
 - 51 Accessories | 25 tons cylinder
 - 52 Accessories | 50 tons cylinder
 - 53 Saddles | tilting saddles
-

HAND TOOLS

- 55 Vertical lifting wedge | spring return
 - 55 Wedge | spring return
 - 56 Wedge | hydraulic return
-

HYDRAULIC PUMPS

- 58 Hand and foot pumps
 - 60 Compact air pumps
 - 61 Compact electric pump
 - 62 Vari pumps | configurator
 - 63 Vari pumps | 230V - 1-stage
 - 64 Vari pumps | 230V - 2-stage
 - 65 Vari pumps | 400V - 1-stage
 - 66 Vari pumps | 400V - 2-stage
 - 67 Vari pumps | twin - 400V - 1-stage
 - 68 Vari pumps | petrol - 2-stage - 4-stroke
 - 70 Control valves | vari pumps
 - 71 Accessories | vari pumps
-

SYSTEM COMPONENTS

- 73 Hydraulic hoses | single hoses
 - 73 Hydraulic hoses | standard hoses
 - 74 Hydraulic hoses | extension hoses
 - 75 Couplers
 - 76 Pressure gauges | scale division in bars
 - 76 Pressure gauges | adaptors
 - 77 FlowPanel™ | single-acting
 - 78 FlowPanel™ | double-acting
 - 79 Valves
 - 80 Accessories hydraulics
 - 82 Assembly materials
 - 84 Oils
 - 85 Lubricants
-

MECHANICAL TOOLS

- 87 Mechanical jacks | cast iron
 - 88 Mechanical pulling jacks
 - 88 Traversing beds
 - 89 Ship wedges
-

SERVICE & SAFETY

- 90 Holmatro Premium Service Program
 - 91 Holmatro Industrial Equipment
-



Holmatro - Mastering Power

Holmatro products are all about the principle that only controlled power can be deployed effectively. We have expressed this vision in the slogan 'Mastering Power'. Still, for over 55 years after the foundation in 1967, we keep honoring our traditional Dutch roots and represent innovation, quality and support. That is why we design, develop, manufacture, and test our tools in-house. Our experience with high-pressure hydraulics enables us to seek out the boundaries of what is technically possible. This has made our tools lighter, compacter, more durable, and easier to use.

128-11033
KRL100-21-8
BLIND OF F.57

ABOUT HOLMATRO

In 1967, Mr. Wessels founded the Holland Machine Trading Company. What started as a trading company, quickly grew into a high-pressure hydraulics specialist for Industrial cylinders with in-house production and development facilities. Nowadays, these cylinders are still the core of all our tools and systems, both Industrial and Rescue.

Over the years, Holmatro developed into a worldwide known & trusted brand. We are proud of the fact that after all this time we are still a **MADE in The Netherlands** company:

- Inhouse research & development
- Inhouse engineering
- 95% of sourcing & production in the Netherlands
- Inhouse quality control*

We always strive to be the best in our field; we want to provide you with the best suitable and safe solution for your application, excellent service and a great customer care.



HOLMATRO INDUSTRIAL EQUIPMENT

We help make the world move forward

Supporting the green energy transition (offshore wind farms, recycling), enabling civil engineering companies to build roads, bridges or moving buildings, helping to place trains back on track, reducing downtime for production facilities and make working with high pressure hydraulics safer; in all these applications and many more, our equipment and service concepts are key to help make the world move forward.



**WE HELP MAKE
THE WORLD MOVE
FORWARD**



* Our state-of-the-art production facilities in Raamsdonksveer, The Netherlands, ensures that the high-grade traditional Dutch quality and robustness is maintained. Work is carried out in accordance with the ISO 9001 Quality Management Standard and the SCC* Safety Health and Environment (SHE) Checklist Contractors. Our products comply with all international standards such as the European EN 13204 and EN 13731. Holmatro tools are developed, manufactured and maintained in conformity with the highest quality standards of durability, side load, mechanical distortion and overpressure. As they must be resistant to the most extreme conditions, our products are thoroughly tested before they are authorized for use in practice.



HOLMATRO INDUSTRIAL TOOLS

With our range of cylinders, pumps and system components, we offer you flexibility and controlled power, from 5 to 300 tons. We offer high-quality products for almost any application. All tools are designed for generating and controlling precision power in various industrial applications, such as maintenance, construction & installation, mining, civil engineering, shipbuilding, heavy transport, petrochemical and offshore. The Industrial Tools range provides you with all needed components to compose your complete hydraulic system. **We are happy to help you find the best and safest solution for your application.**



HOLMATRO INDUSTRIAL CUTTING TOOLS

Our Industrial Cutting Tools are designed to handle a variety of materials, to endure a high frequency use and reduce physical risks and demands. The main application focus of our Industrial Cutting Tools lies in the field of recycling, demolition, production and decommissioning industries.



HOLMATRO INDUSTRIAL SYSTEMS

Rerailing rolling stock, levelling and fixation of offshore wind mills, turbine transport, generator installations, ship launching: moving, adjusting or levelling heavy loads require controlled forces. One of the conditions for achieving this is that your system of choice is safe, easy to use and to deploy. User-friendliness is therefore the starting point for all our industrial systems: both in operation and functionality. Lifting, pushing, pulling, lowering, weighing, tilting or horizontal movement; **whatever direction your project moves in, we move with you.**



Rerailing

Discover Holmatro's World of Rerailing!

When a railway vehicle derails, the wish is to have the vehicle back on track in no time in a safe and controlled manner. Therefore a system needs to be in place that gets the job done. Holmatro offers rerailing systems that are suitable for different rerailing applications.

The Holmatro rerailing systems are built with three main elements in mind:

- Safe
- Fast
- Controllable



Offshore Wind

We have proven ourselves in the field of TP levelling and TP fixation, jacket fixation, cutting applications, seafastening systems and skidding solutions. Holmatro is your proven partner for your offshore wind project.

HOLMATRO PARTNER NETWORK

At Holmatro Industrial Equipment, we believe in the power of joint success. We are proud of our network of dedicated local partners; they give excellent support to our customers with their expertise and knowledge of their market.



'Holmatro and Fyns Kran Udstyr A/S has a partnership for many years. We are very happy to have a partnership with a very serious and dedicated company like Holmatro. Over the years we have come to know each other very well and we have a very open dialogue with Holmatro. We have chosen a partnership with Holmatro because they deliver top quality products which is a perfect match with the other products in our large product portfolio of lifting gear. We look forward to the future together with Holmatro and hopefully with a lot of new projects and challenges that we can solve together.'

Torben Wiberg, Product Manager, Fyns Kran Udstyr A/S

HOLMATRO PREMIUM SERVICE PROGRAM

Correct & periodic maintenance can prevent unnecessary damages, costs, and unsafe situations. This is why we offer you a complete service program for high pressure hydraulic tools.



How we test

Our years of experience have learned that there is only one correct way to determine if a hydraulic system is safe to use: dynamic testing. With dynamic testing, we simulate a max. use situation of the cylinder in a controlled environment. By doing so, hidden defects will be identified sooner, ensuring the reliability and safety of your tools.

How we train

Working with high pressure hydraulics comes with great responsibility. For you as an employer, it is important to inform and train your employees and keep them safe. We help you understand the risks related to high-pressure hydraulics, with on- and offline tools. Not only to help keep your employees safe, but also meet your legal obligations.



SCAN THE QR CODE
and discover more
applications on our website.

BASIC KNOWLEDGE OF HYDRAULICS

Pascal's law

Pressure applied at any point upon a confined liquid is transmitted undiminished in all directions (fig. 1).

According to Pascal's law, the oil flow always chooses the line of least resistance in a hydraulic system. This means that when using several hydraulic cylinders, each cylinder lifts at its own speed. When the cylinders have the same capacity, they will first start moving at the point of the lightest load and last at the point of the heaviest load (fig. 2).

A FlowPanel™ must be added to the lifting system to make sure that the oil flow can be controlled such, that all cylinders operate evenly and the load can be lifted horizontally (fig. 3).

Figure 1

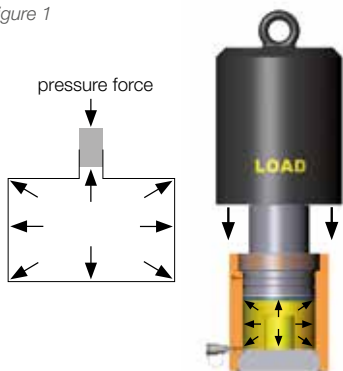

Figure 2



Figure 3



Recommended total cylinder capacity

In connection with various uncertainties as mentioned below, Holmatro recommends a system with sufficient extra capacity:

- The exact weight of the load
- The spreading of the load among the cylinders
- Possible moving of the load in case of calamities

SYMMETRIC LOAD



Recommended total cylinder capacity = 1.5 x load

ASYMMETRIC LOAD



Recommended total cylinder capacity = 2 x load

Force of a cylinder

The force (capacity) generated by a cylinder is equal to the hydraulic pressure multiplied by the effective pressure area of the plunger.

$$\text{force} = \text{hydraulic operating pressure} \times \text{effective pressure area of the plunger}$$

N	=	N/cm ²	x	cm ²
F	=	P	x	A
P	=	F	/	A
A	=	F	/	P

This formula can be used for determining the force, pressure or the area when two out of three variables are known.

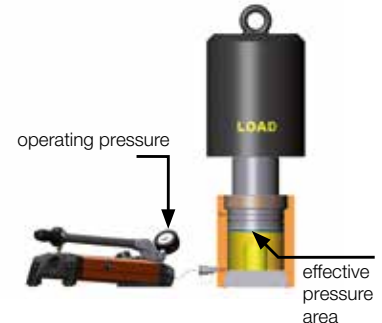

Recommended total cylinder capacity

Min. eff. tank volume of pump = (oil volume of cylinder 1 + 2 + ...) x 1,2
(safety margin)

Oil volume of a cylinder; the volume in cm³ required for achieving the full stroke of the cylinder. For oil volume specifications see section 'Hydraulic cylinders'.

NB. For double-acting cylinders: Reduce the volume above the plunger section with the volume under the plunger section.



Required operating speed

$$\text{Operating speed} = \frac{\text{oil volume of cylinders 1 + 2 + ...}}{\text{pump output}}$$

- Operating speed; with hand/foot pumps: the number of pump strokes required for fully pumping out the cylinder. With motor pumps: the number of minutes required for fully pumping out the cylinder.
- Oil volume of cylinders; with hand/foot pumps: the volume in cm³ required for achieving the full cylinder stroke. With motor pumps: the volume in litres required for achieving the full cylinder stroke. See table on product pages.

NB. When two figures are given, only take the value for below or above the plunger part.

- Pump output; with hand/foot pumps: the output of the pump in cm³/stroke. With motor pumps: the output of the pump in l/min. See tables in section 'Hydraulic pumps', for the output of your pump.

Important conversion factors

1	bar	=	1,10197	kg/cm ²
1	bar	=	14,504	psi
1	bar	=	100	kPa
1	bar	=	0,1	MPa
1	bar	=	10	N/cm ²
1	ton	=	9,80665	kN
1	ton	=	9806,65	N
1	ton	=	1000	kg
1	cm ²	=	0,155	in ²
1	cm ³	=	0,06102	in ³
1	cm ³	=	0,001	l
1	kgf	=	9,8066	N
1	kg	=	2,2046	lb



1	kg/cm ²	=	0,98066	bar
1	psi	=	0,0689	bar
1	kPa	=	0,01	bar
1	MPa	=	10	bar
1	N/cm ²	=	0,1	bar
1	kN	=	0,1020	ton
1	N	=	0,0001	ton
1	kg	=	0,001	ton
1	in ²	=	6,4516	cm ²
1	in ³	=	16,3881	cm ³
1	l	=	1000	cm ³
1	N	=	0,1020	kgf
1	lb	=	0,4536	kg



HYDRAULIC CYLINDERS

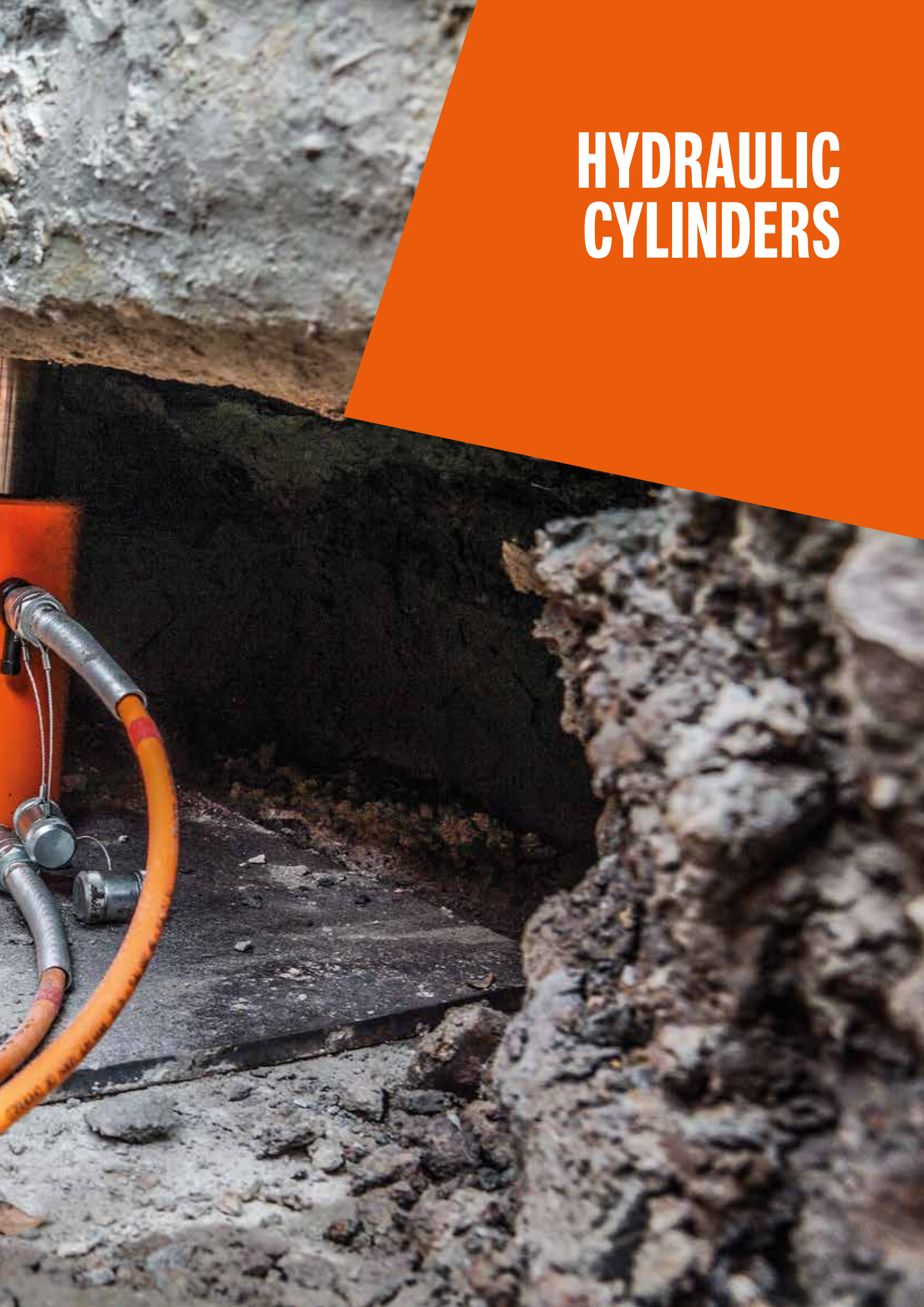

COMPOSING A HYDRAULIC CYLINDER SYSTEM

3-step plan for composing a hydraulic cylinder system

Step 1

Select one or more cylinders

Considerations:

- What is the weight of the load to be lifted?
- What is the total recommended cylinder capacity?
- With how many cylinders must/can the load be lifted?
- What capacity for each cylinder is required then?
- What is the required stroke length of the cylinder?
- What is the required closed height (overall dimensions) of the cylinder?
- How must the plunger return; gravity, spring or hydraulic?
- Is lifting in one or more steps possible?

See 'Selection list cylinders'

Step 2

Select the proper pump

Considerations:

- Select from hand, foot, pneumatically, electrically or petrol driven pumps.
- Hand / foot pumps: with a double-acting cylinder (hydraulic return), mount a double-acting valve on your hand pump (only possible with PA *8 models).
- Vari pumps: dependent on whether you use a single- or double-acting cylinder, mount a single-acting or double-acting valve on the Vari pump.
- What minimum tank volume of the pump is required?
- Select a pump output corresponding with the required operating speed.

See section 'Hydraulic pumps'

Step 3

Select the accessories you need

Considerations:

- Choose the correct number of hoses that you need and the required length. Take the required (safe) distance between cylinders and operation (pump and/or valve block) into account.
- When the system contains several cylinders controlled by one pump, we recommend you to install a FlowPanel™ between the cylinders and the pump for accurate control of the oil flow to the cylinders.
- Select any necessary couplers, pressure gauges, valves and/or assembly material.

See section 'System components'

Four examples of a hydraulic cylinder system

no	description	art no	page
1	hand pump PA 18 H 2	100.142.035	58
2	pressure gauge set for PA *8 pumps	100.182.214	59
3	hydraulic hose H 2 SOU	100.572.102	73
4	single-acting cylinder	-	14
5	hydraulic hose VL 5 SOU	100.572.305	74
6	FlowPanel™ HMS 4 C	100.172.047	77
7	High Flow coupler, female, A 118	100.181.118	75
8	High Flow coupler, male, A 119	100.181.119	75
9	nipple 3/8" NPT, male	100.581.101	83
10	T-piece	100.001.010	80
11	manifold	100.181.125	81

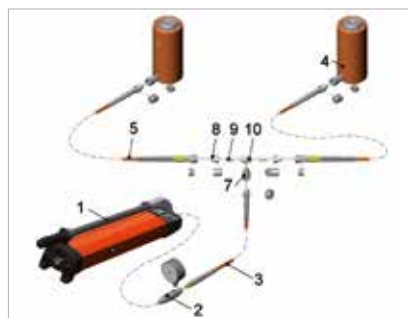
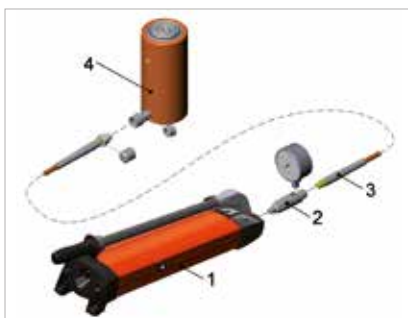
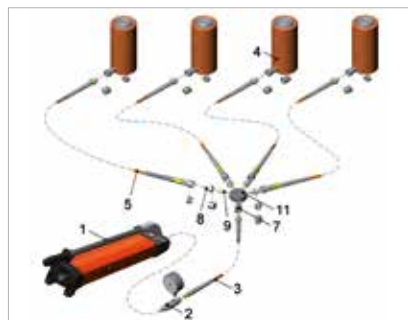
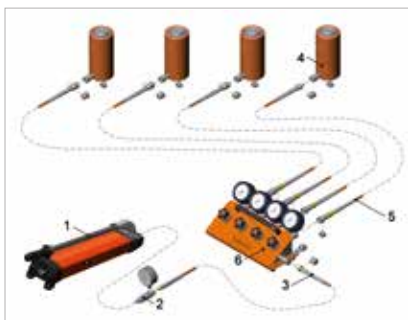

**ANY QUESTIONS?
OUR SALES DEPARTMENT
IS HAPPY TO ASSIST!**



HOLMATRO CYLINDERS

Various return types

The Holmatro product portfolio includes a large range of different cylinders which come in different types and 3 different return types. A short explanation about the standard return types and the models will be given below.

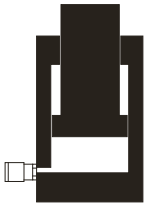

Gravity return

Return of the plunger by means of the load or another external force.

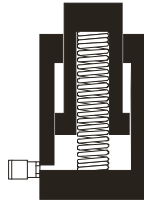

Spring return

Return of the plunger by means of a spring integrated in the cylinder.

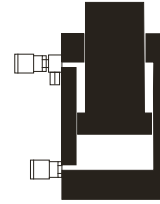

Hydraulic return

Return of the plunger by means of hydraulic pressure. Cylinders in which the plunger hydraulically extends and returns are also called 'double-acting' cylinders.

Various cylinder types



Multi Purpose cylinders - spring return

With a lifting capacity of 5 up to 100 tons and a stroke length between 50 and 250 mm the Multi Purpose cylinder range is the most extensive on the market and suitable for the most varied applications. The cylinders are fitted with base mounting holes and collar thread. There is also internal plunger thread on all models to 50 tons.



Aluminium cylinders - spring & hydraulic return

The Aluminium cylinders combine the best of two worlds; They are more than 50% lighter, but are just as robust as their steel equivalent. With a lifting capacity of 20 up to 150 tons and a stroke length between 50 and 250 mm the cylinder range is very suitable for lifting activities requiring frequently moving the cylinder, making a low weight essential.



Flat cylinders - spring return

Cylinders with a very low construction height and a lifting capacity of 5 up to 100 tons. Especially developed in case of limited insertion space.



High tonnage cylinders - gravity & hydraulic return

Cylinders with a lifting capacity of 50 up to 300 tons and a stroke length between 50 and 300 mm. Very suitable for heavy lifting activities.



Telescopic cylinders - gravity return

Cylinders with a very low construction height, two different capacities and stroke lengths in one cylinder. Very suitable for various adjustment activities.



Locknut cylinders - gravity & hydraulic return

Cylinders with mechanical load locking, a lifting capacity of 50 up to 250 tons and a stroke length between 50 and 300 mm. Because of the smart return-plunger the hydraulic return locknut cylinders are hardly higher than the gravity return locknut cylinders. All suitable for sustained load because of mechanical load locking.



Aluminium hollow plunger cylinders - spring & hydraulic return

Aluminium cylinders with a hollow plunger for both pushing and pulling, with a capacity of 20 up to 150 tons and a stroke length between 50 and 250 mm. Especially developed for pulling using pulling rods.



Hollow plunger cylinders - gravity, spring & hydraulic return

Cylinders with a hollow plunger for both pushing and pulling, with a capacity of 5 up to 110 tons and a stroke length varying between 25 and 150 mm. Especially developed for pulling using pulling rods.



Short stroke cylinders - spring return

Cylinders with a short stroke, a low construction height and a lifting capacity of 10 up to 100 tons. Very suitable for general lifting activities.



Pulling cylinders - spring & hydraulic return

Cylinders with a pulling capacity of 11 up to 60 tons and a stroke length of 150 mm. Especially developed for, among other things, pulling heavy objects towards each other.

SELECTION LIST | cylinders

capacity	stroke	closed height	Ø hole in plunger	return	type	material	model	art no	page
tons	mm	mm	mm						
5	15	44		spring	flat	steel	HFC 5 S 1.5	100.112.291	20
	25	87	17	spring	hollow plunger	steel	HHJ 5 S 2.5	100.111.002	39
	50	130		spring	multi purpose	steel	HGC 5 S 5	100.112.212	17
	75	155		spring	multi purpose	steel	HGC 5 S 7.5	100.112.213	17
	125	206		spring	multi purpose	steel	HGC 5 S 12.5	100.112.215	17
	175	268		spring	multi purpose	steel	HGC 5 S 17.5	100.112.216	17
10	15	46		spring	flat	steel	HFC 10 S 1.5	100.112.292	20
	21 / 20	49		gravity	telescopic	steel	HFJ 10/30 G 4	100.111.005	31
	50	100		spring	short stroke	steel	HSC 10 S 5	100.112.300	22
	50	122		spring	multi purpose	steel	HGC 10 S 5	100.112.219	17
	100	172		spring	multi purpose	steel	HGC 10 S 10	100.112.220	17
	150	240		spring	multi purpose	steel	HGC 10 S 15	100.112.221	18
	200	290		spring	multi purpose	steel	HGC 10 S 20	100.112.222	18
	250	340		spring	multi purpose	steel	HGC 10 S 25	100.112.223	18
12	50	156	21	spring	hollow plunger	steel	HHJ 12 S 5	100.111.021	39
15	50	148		spring	multi purpose	steel	HGC 15 S 5	100.112.228	18
	100	198		spring	multi purpose	steel	HGC 15 S 10	100.112.229	18
	150	265		spring	multi purpose	steel	HGC 15 S 15	100.112.230	18
	200	315		spring	multi purpose	steel	HGC 15 S 20	100.112.231	18
	250	365		spring	multi purpose	steel	HGC 15 S 25	100.112.232	18
17	50	192	27	spring	hollow plunger	steel	HHJ 17 S 5	100.112.023	39
20	15	55		spring	flat	steel	HFC 20 S 1.5	100.112.293	20
	50	103		spring	short stroke	steel	HSC 20 S 5	100.112.301	22
	50	182	27	spring	hollow plunger	steel	HHJ 20 S 5	100.112.033	39
	50	170	27	spring	hollow plunger	aluminium	HAHC 20 S 5	100.112.366	35
	56 / 55	140		gravity	telescopic	steel	HJ 20/50 G 11	100.112.103	31
	50	164		spring	standard	aluminium	HAC 20 S 5	100.112.267	23
	100	214		spring	standard	aluminium	HAC 20 S 10	100.112.265	23
	100	240	27	spring	hollow plunger	aluminium	HAHC 20 S 10	100.112.367	35
	150	264		spring	standard	aluminium	HAC 20 S 15	100.112.261	23
	150	389	27	spring	hollow plunger	steel	HHJ 20 S 15	100.112.030	39
	150	310	27	spring	hollow plunger	aluminium	HAHC 20 S 15	100.112.368	35
	200	375	27	spring	hollow plunger	aluminium	HAHC 20 S 20	100.112.369	35
	250	429	27	spring	hollow plunger	aluminium	HAHC 20 S 25	100.112.370	35
25	50	165		spring	multi purpose	steel	HGC 25 S 5	100.112.237	18
	100	215		spring	multi purpose	steel	HGC 25 S 10	100.112.238	18
	150	265		spring	multi purpose	steel	HGC 25 S 15	100.112.239	18
	200	315		spring	multi purpose	steel	HGC 25 S 20	100.112.240	18
	250	374		spring	multi purpose	steel	HGC 25 S 25	100.112.241	18
30	15	60		spring	flat	steel	HFC 30 S 1.5	100.112.295	20
	50	106		spring	short stroke	steel	HSC 30 S 5	100.112.302	22
	50	182		spring	standard	aluminium	HAC 30 S 5	100.112.269	23
	50	197		hydraulic	standard	aluminium	HAC 30 H 5	100.122.086	25
	50	120	33	gravity	hollow plunger	steel	HHJ 30 G 5	100.111.053	42
	50	185	34	spring	hollow plunger	aluminium	HAHC 30 S 5	100.112.371	36
	75	226	33	spring	hollow plunger	steel	HHJ 30 S 7.5	100.112.055	40
	100	232		spring	standard	aluminium	HAC 30 S 10	100.112.268	23
	100	247		hydraulic	standard	aluminium	HAC 30 H 10	100.122.085	25
	100	255	34	spring	hollow plunger	aluminium	HAHC 30 S 10	100.112.372	36
	150	282		spring	standard	aluminium	HAC 30 S 15	100.112.262	23
	150	297		hydraulic	standard	aluminium	HAC 30 H 15	100.122.080	25

SELECTION LIST

capacity	stroke	closed height	Ø hole in plunger	return	type	material	model	art no	page
tons	mm	mm	mm						
30	150	285	33	hydraulic	hollow plunger	steel	HHJ 30 H 15	100.122.045	41
	150	362	33	spring	hollow plunger	steel	HHJ 30 S 15	100.112.034	40
	150	325	34	spring	hollow plunger	aluminium	HAHC 30 S 15	100.112.373	36
	200	390	34	spring	hollow plunger	aluminium	HAHC 30 S 20	100.112.374	36
	250	450	34	spring	hollow plunger	aluminium	HAHC 30 S 25	100.112.375	36
35	50	184		spring	multi purpose	steel	HGC 35 S 5	100.112.245	18
	100	234		spring	multi purpose	steel	HGC 35 S 10	100.112.246	18
	150	284		spring	multi purpose	steel	HGC 35 S 15	100.112.247	18
	200	334		spring	multi purpose	steel	HGC 35 S 20	100.112.248	18
45	150	388	39	spring	hollow plunger	steel	HHJ 45 S 15	100.112.061	40
50	15	71		spring	flat	steel	HFC 50 S 1.5	100.112.296	21
	50	117		spring	short stroke	steel	HSC 50 S 5	100.112.303	22
	50	208		hydraulic	lock nut	steel	HLC 50 H 5	100.122.123	33
	50	176		spring	multi purpose	steel	HGC 50 S 5	100.112.249	19
	50	183		spring	standard	aluminium	HAC 50 S 5	100.112.271	24
	50	201		hydraulic	standard	aluminium	HAC 50 H 5	100.122.095	25
	60	142		gravity	high tonnage	steel	HJ 50 G 6	100.112.073	27
	100	226		spring	multi purpose	steel	HGC 50 S 10	100.112.250	19
	100	233		spring	standard	aluminium	HAC 50 S 10	100.112.270	24
	100	251		hydraulic	standard	aluminium	HAC 50 H 10	100.122.108	25
	150	276		spring	multi purpose	steel	HGC 50 S 15	100.112.251	19
	150	282		gravity	high tonnage	steel	HJ 50 G 15	100.112.035	27
	150	282		hydraulic	high tonnage	steel	HJ 50 H 15	100.122.002	29
	150	283		spring	standard	aluminium	HAC 50 S 15	100.112.263	24
	150	301		hydraulic	standard	aluminium	HAC 50 H 15	100.122.097	25
	150	307		gravity	lock nut	steel	HJ 50 G 15 SN	100.082.001	32
	150	327		hydraulic	lock nut	steel	HLC 50 H 15	100.122.124	33
	200	236		spring	multi purpose	steel	HGC 50 S 20	100.112.252	19
	250	376		spring	multi purpose	steel	HGC 50 S 25	100.112.253	19
	300	463		gravity	high tonnage	steel	HJ 50 G 30	100.112.036	27
	300	463		hydraulic	high tonnage	steel	HJ 50 H 30	100.122.022	29
	300	498		hydraulic	lock nut	steel	HLC 50 H 30	100.122.125	33
60	50	243	56	spring	hollow plunger	aluminium	HAHC 60 S 5	100.112.376	36
	75	272	45	spring	hollow plunger	steel	HHJ 60 S 7.5	100.112.081	40
	100	295	56	spring	hollow plunger	aluminium	HAHC 60 S 10	100.112.377	36
	150	363	56	spring	hollow plunger	steel	HAHC 60 S 15	100.112.378	36
	200	334	45	hydraulic	hollow plunger	aluminium	HHJ 60 H 20	100.122.031	41
	200	428	56	spring	hollow plunger	aluminium	HAHC 60 S 20	100.112.379	36
	250	518	56	spring	hollow plunger	aluminium	HAHC 60 S 25	100.112.380	36
75	15	80		spring	flat	steel	HFC 75 S 1.5	100.112.297	21
	150	285		spring	multi purpose	steel	HGC 75 S 15	100.112.255	19
	350	485		spring	multi purpose	steel	HGC 75 S 35	100.112.256	19
100	15	90		spring	flat	steel	HFC 100 S 1.5	100.112.298	21
	50	141		spring	short stroke	steel	HSC 100 S 5	100.112.304	22
	50	170		hydraulic	high tonnage	steel	HJ 100 H 5	100.122.009	29
	50	218		spring	multi purpose	steel	HGC 100 S 5	100.112.257	19
	50	225		spring	standard	aluminium	HAC 100 S 5	100.112.273	24
	50	246		hydraulic	standard	aluminium	HAC 100 H 5	100.122.094	26
	50	248		hydraulic	lock nut	steel	HLC 100 H 5	100.122.126	33
	50	229	80	hydraulic	hollow plunger	aluminium	HAHC 100 H 5	100.112.381	37
	60	157		gravity	high tonnage	steel	HJ 100 G 6	100.112.093	27

SELECTION LIST

capacity	stroke	closed height	Ø hole in plunger	return	type	material	model	art no	page
tons	mm	mm	mm						
	100	268		spring	multi purpose	steel	HGC 100 S 10	100.112.258	19
	100	275		spring	standard	aluminium	HAC 100 S 10	100.112.272	24
	100	296		hydraulic	standard	aluminium	HAC 100 H 10	100.122.109	26
	100	279	80	hydraulic	hollow plunger	aluminium	HAHC 100 H 10	100.112.382	37
	150	309		gravity	high tonnage	steel	HJ 100 G 15	100.112.039	27
	150	309		hydraulic	high tonnage	steel	HJ 100 H 15	100.122.052	29
	150	318		spring	multi purpose	steel	HGC 100 S 15	100.112.259	19
	150	323		gravity	lock nut	steel	HJ 100 G 15 SN	100.082.000	32
	150	325		spring	standard	aluminium	HAC 100 S 15	100.112.264	24
	150	346		hydraulic	standard	aluminium	HAC 100 H 15	100.122.107	26
	150	370		hydraulic	lock nut	aluminium	HLC 100 H 15	100.122.127	33
	150	329	80	hydraulic	hollow plunger	aluminium	HAHC 100 H 15	100.112.383	37
	200	395	54	hydraulic	hollow plunger	steel	HHJ 100 H 20	100.122.053	41
	200	429	80	hydraulic	hollow plunger	aluminium	HAHC 100 H 20	100.112.384	37
	250	418		spring	multi purpose	steel	HGC 100 S 25	100.112.260	19
	250	429	80	hydraulic	hollow plunger	aluminium	HAHC 100 H 25	100.112.385	37
	300	497		gravity	high tonnage	steel	HJ 100 G 30	100.112.040	27
	300	497		hydraulic	high tonnage	steel	HJ 100 H 30	100.122.054	29
	300	546		hydraulic	lock nut	steel	HLC 100 H 30	100.122.128	33
110	50	315	80	spring	hollow plunger	steel	HHJ 110 S 7.5	100.112.101	40
150	50	248		hydraulic	standard	aluminium	HAC 150 H 5	100.122.075	26
	50	275		hydraulic	lock nut	steel	HLC 150 H 5	100.122.129	34
	50	247	80	hydraulic	hollow plunger	aluminium	HAHC 150 H 5	100.112.386	38
	100	298		hydraulic	standard	aluminium	HAC 150 H 10	100.122.074	26
	100	297	80	hydraulic	hollow plunger	aluminium	HAHC 150 H 10	100.112.387	38
	150	317		gravity	high tonnage	steel	HJ 150 G 15	100.112.046	28
	150	317		hydraulic	high tonnage	steel	HJ 150 H 15	100.122.061	29
	150	348		hydraulic	standard	aluminium	HAC 150 H 15	100.122.073	26
	150	363		gravity	lock nut	steel	HJ 150 G 15 SN	100.112.136	32
	150	400		hydraulic	lock nut	steel	HLC 150 H 15	100.122.130	34
	150	347	80	spring	hollow plunger	aluminium	HAHC 150 H 15	100.112.388	38
	200	397	80	hydraulic	hollow plunger	aluminium	HAHC 150 H 20	100.112.389	38
	250	447	80	hydraulic	hollow plunger	aluminium	HAHC 150 H 25	100.112.390	38
	300	502		gravity	high tonnage	steel	HJ 150 G 30	100.112.047	28
	300	502		hydraulic	high tonnage	steel	HJ 150 H 30	100.122.062	30
	300	580		hydraulic	lock nut	steel	HLC 150 H 30	100.122.131	34
200	150	327		gravity	high tonnage	steel	HJ 200 G 15	100.112.048	28
	150	327		hydraulic	high tonnage	steel	HJ 200 H 15	100.122.071	30
	300	507		gravity	high tonnage	steel	HJ 200 G 30	100.112.049	28
	300	507		hydraulic	high tonnage	steel	HJ 200 H 30	100.122.072	30
250	50	317		hydraulic	lock nut	steel	HLC 250 H 5	100.122.132	34
	150	385		gravity	lock nut	steel	HJ 250 G 15 SN	100.112.083	32
	150	444		hydraulic	lock nut	steel	HLC 250 H 15	100.122.133	34
	300	625		hydraulic	lock nut	steel	HLC 250 H 30	100.122.134	34
300	150	382		gravity	high tonnage	steel	HJ 300 G 15	100.112.050	28
	150	382		hydraulic	high tonnage	steel	HJ 300 H 15	100.122.084	30
	300	547		gravity	high tonnage	steel	HJ 300 G 30	100.112.099	28
	300	547		hydraulic	high tonnage	steel	HJ 300 H 30	100.122.083	30

MULTI PURPOSE CYLINDERS | spring return



Features & benefits

- A range of products with different tonnages and stroke lengths
- Collar thread and base mounting holes
- Internal plunger thread on all models to 50 tons
- Duo Power Ring; seal, bearings and resistance to side loads to a maximum of 10% for a longer life span (image 1 and 2)
- Duplex Power Coating makes the plunger corrosion-resistant (image 3)
- XL Saddle+ protects the plunger and limits eccentric loads (image 4)
- Thread Protector protects the thread on the cylinder housing

Standard supplied with

- High Flow female coupler A 118
- Flat saddle

Accessories	49
Tilting saddles	53
Hydraulic pumps	57
Hydraulic hoses	73
Pressure gauges	76



specifications		HGC 5 S 5	HGC 5 S 7.5	HGC 5 S 12.5	HGC 5 S 17.5	HGC 10 S 5	HGC 10 S 10
art no		100.112.212	100.112.213	100.112.215	100.112.216	100.112.219	100.112.220
max. working pressure	bar/Mpa	720 / 72	720 / 72	720 / 72	720 / 72	720 / 72	720 / 72
tonnage	t	5	5	5	5	10	10
stroke	mm	50	75	125	175	50	100
closed height	mm	130	155	206	268	122	172
diameter (B)	mm	40	40	40	40	60	60
capacity	kN/t	51 / 5.2	51 / 5.2	51 / 5.2	51 / 5.2	100 / 10.2	100 / 10.2
effective pressure area	cm ²	7.1	7.1	7.1	7.1	13.9	13.9
required oil content (effective)	cc	35	53	88	124	69	139
connection		A 118	A 118	A 118	A 118	A 118	A 118
cylinder type		multi purpose	multi purpose	multi purpose	multi purpose	multi purpose	multi purpose
acting type		single	single	single	single	single	single
return type		spring	spring	spring	spring	spring	spring
material		steel	steel	steel	steel	steel	steel
weight, ready for use	kg	1.3	1.5	1.8	2.3	2.5	3.4

specifications		HGC 10 S 15	HGC 10 S 20	HGC 10 S 25	HGC 15 S 5	HGC 15 S 10	HGC 15 S 15
art no		100.112.221	100.112.222	100.112.223	100.112.228	100.112.229	100.112.230
max. working pressure	bar/Mpa	720 / 72	720 / 72	720 / 72	720 / 72	720 / 72	720 / 72
tonnage	t	10	10	10	15	15	15
stroke	mm	150	200	250	50	100	150
closed height	mm	240	290	340	148	198	265
diameter (B)	mm	60	60	60	70	70	70
capacity	kN/t	100 / 10.2	100 / 10.2	100 / 10.2	171 / 17.4	171 / 17.4	171 / 17.4
effective pressure area	cm ²	13.9	13.9	13.9	23.8	23.8	23.8
required oil content (effective)	cc	208	277	346	119	238	356
connection		A 118	A 118	A 118	A 118	A 118	A 118
cylinder type		multi purpose	multi purpose	multi purpose	multi purpose	multi purpose	multi purpose
acting type		single	single	single	single	single	single
return type		spring	spring	spring	spring	spring	spring
material		steel	steel	steel	steel	steel	steel
weight, ready for use	kg	4.6	5.5	6.4	3.9	4.9	6.4

specifications		HGC 15 S 20	HGC 15 S 25	HGC 25 S 5	HGC 25 S 10	HGC 25 S 15	HGC 25 S 20
art no		100.112.231	100.112.232	100.112.237	100.112.238	100.112.239	100.112.240
max. working pressure	bar/Mpa	720 / 72	720 / 72	720 / 72	720 / 72	720 / 72	720 / 72
tonnage	t	15	15	25	25	25	25
stroke	mm	200	250	50	100	150	200
closed height	mm	315	365	165	215	265	315
diameter (B)	mm	70	70	85	85	85	85
capacity	kN/t	171 / 17.4	171 / 17.4	239 / 24.4	239 / 24.4	239 / 24.4	239 / 24.4
effective pressure area	cm ²	23.8	23.8	33.2	33.2	33.2	33.2
required oil content (effective)	cc	475	594	166	332	498	664
connection		A 118	A 118	A 118	A 118	A 118	A 118
cylinder type		multi purpose	multi purpose	multi purpose	multi purpose	multi purpose	multi purpose
acting type		single	single	single	single	single	single
return type		spring	spring	spring	spring	spring	spring
material		steel	steel	steel	steel	steel	steel
weight, ready for use	kg	7.4	8.4	6.4	8.0	9.7	11.3

specifications		HGC 25 S 25	HGC 35 S 5	HGC 35 S 10	HGC 35 S 15	HGC 35 S 20
art no		100.112.241	100.112.245	100.112.246	100.112.247	100.112.248
max. working pressure	bar/Mpa	720 / 72	720 / 72	720 / 72	720 / 72	720 / 72
tonnage	t	25	35	35	35	35
stroke	mm	250	50	100	150	200
closed height	mm	374	184	234	284	334
diameter (B)	mm	85	100	100	100	100
capacity	kN/t	239 / 24.4	362 / 36.9	362 / 36.9	362 / 36.9	362 / 36.9
effective pressure area	cm ²	33.2	50.3	50.3	50.3	50.3
required oil content (effective)	cc	830	251	503	754	1005
connection		A 118	A 118	A 118	A 118	A 118
cylinder type		multi purpose	multi purpose	multi purpose	multi purpose	multi purpose
acting type		single	single	single	single	single
return type		spring	spring	spring	spring	spring
material		steel	steel	steel	steel	steel
weight, ready for use	kg	13.3	9.3	11.4	13.5	15.5

specifications		HGC 50 S 5	HGC 50 S 10	HGC 50 S 15	HGC 50 S 20	HGC 50 S 25
art no		100.112.249	100.112.250	100.112.251	100.112.252	100.112.253
max. working pressure	bar/Mpa	720 / 72	720 / 72	720 / 72	720 / 72	720 / 72
tonnage	t	50	50	50	50	50
stroke	mm	50	100	150	200	250
closed height	mm	176	226	276	326	376
diameter (B)	mm	127	127	127	127	127
capacity	kN/t	510 / 52	510 / 52	510 / 52	510 / 52	510 / 52
effective pressure area	cm ²	70.9	70.9	70.9	70.9	70.9
required oil content (effective)	cc	354	709	1063	1418	1772
connection		A 118	A 118	A 118	A 118	A 118
cylinder type		multi purpose	multi purpose	multi purpose	multi purpose	multi purpose
acting type		single	single	single	single	single
return type		spring	spring	spring	spring	spring
material		steel	steel	steel	steel	steel
weight, ready for use	kg	15.1	18.9	22.6	26.4	30.1

specifications		HGC 75 S 15	HGC 75 S 35	HGC 100 S 5	HGC 100 S 10	HGC 100 S 15	HGC 100 S 25
art no		100.112.255	100.112.256	100.112.257	100.112.258	100.112.259	100.112.260
max. working pressure	bar/Mpa	720 / 72	720 / 72	720 / 72	720 / 72	720 / 72	720 / 72
tonnage	t	75	75	100	100	100	100
stroke	mm	150	350	50	100	150	250
closed height	mm	285	485	218	268	318	418
diameter (B)	mm	147	147	175	175	175	175
capacity	kN/t	748 / 76.3	748 / 76.3	1031 / 105.1	1031 / 105.1	1031 / 105.1	1031 / 105.1
effective pressure area	cm ²	103.9	103.9	143.1	143.1	143.1	143.1
required oil content (effective)	cc	1558	3635	716	1431	2147	3579
connection		A 118	A 118	A 118	A 118	A 118	A 118
cylinder type		multi purpose	multi purpose	multi purpose	multi purpose	multi purpose	multi purpose
acting type		single	single	single	single	single	single
return type		spring	spring	spring	spring	spring	spring
material		steel	steel	steel	steel	steel	steel
weight, ready for use	kg	30.9	50.0	35.3	42.2	50.0	64.1



FLAT CYLINDERS | spring return



Features & benefits

- Compact, flat version, efficient in case of limited insertion space
- Usable in all positions
- Standard provided with fixing holes for easy assembly
- Protected against ejection of the plunger
- Dirt scraper ring
 - Protects against pollution
 - Increases the life span
- Splined plunger, no saddle needed

Hydraulic pumps	57
Hydraulic hoses	73
Pressure gauges	76

Standard supplied with

- High Flow female coupler A 118

specifications		HFC 5 S 1.5	HFC 10 S 1.5	HFC 20 S 1.5	HFC 30 S 1.5
art no		100.112.291	100.112.292	100.112.293	100.112.295
max. working pressure	bar/Mpa	720 / 72	720 / 72	720 / 72	720 / 72
tonnage	t	5	10	20	30
stroke	mm	15	15	15	15
closed height	mm	44	46	55	60
diameter (B)	mm	60	85	100	116
capacity	kN/t	50.9 / 5.2	99.8 / 10.2	203.6 / 20.8	318.1 / 32.4
effective pressure area	cm ²	7.1	13.9	28.3	44.2
required oil content (effective)	cc	11	28.8	42.4	66.3
connection		A 118	A 118	A 118	A 118
hose					
cylinder type		flat	flat	flat	flat
acting type		single	single	single	single
return type		spring	spring	spring	spring
material		steel	steel	steel	steel
weight, ready for use	kg	1.0	1.6	2.9	4.2

specifications		HFC 50 S 1.5	HFC 75 S 1.5	HFC 100 S 1.5
art no		100.112.296	100.112.297	100.112.298
max. working pressure	bar/Mpa	720 / 72	720 / 72	720 / 72
tonnage	t	50	75	100
stroke	mm	15	15	15
closed height	mm	71	80	90
diameter (B)	mm	140	165	190
capacity	kN/t	510.4 / 52	747.9 / 76.3	1030.5 / 105.1
effective pressure area	cm ²	70.9	103.9	143.1
required oil content (effective)	cc	106	156	215
connection		A 118	A 118	A 118
cylinder type		flat	flat	flat
acting type		single	single	single
return type		spring	spring	spring
material		steel	steel	steel
weight, ready for use	kg	7.0	11.0	18.1



SHORT STROKE CYLINDERS | spring return



Features & benefits

- Compact, short stroke version, efficient in case of limited insertion space
- 50 mm stroke length
- Protected against ejection of the plunger
- Dirt scraper ring
 - Protects against pollution
 - Increases the life span
- Splined plunger, no saddle needed

Hydraulic pumps	57
Hydraulic hoses	73
Pressure gauges	76

Standard supplied with

- High Flow female coupler A 118

specifications		HSC 10 S 5	HSC 20 S 5	HSC 30 S 5	HSC 50 S 5	HSC 100 S 5
art no		100.112.300	100.112.301	100.112.302	100.112.303	100.112.304
max. working pressure	bar/Mpa	720 / 72	720 / 72	720 / 72	720 / 72	720 / 72
tonnage	t	10	20	30	50	100
stroke	mm	50	50	50	50	50
closed height	mm	100	103	106	117	141
diameter (B)	mm	70	98	104	128	173
capacity	kN/t	99.8 / 10.2	203.6 / 20.8	318.1 / 32.4	510.4 / 52	1030.6 / 105.1
effective pressure area	cm ²	13.9	28.3	44.2	70.9	143.1
required oil content (effective)	cc	69.3	141.4	221	354	716
connection		A 118	A 118	A 118	A 118	A 118
cylinder type		short stroke	short stroke	short stroke	short stroke	short stroke
acting type		single	single	single	single	single
return type		spring	spring	spring	spring	spring
material		steel	steel	steel	steel	steel
weight, ready for use	kg	2.9	5.5	6.1	9.7	22.2

ALUMINIUM CYLINDERS | spring return



Features & benefits

- 50% lighter cylinders; easy to work with and better for the welfare of the user
- Duo Power Ring; seal, bearings and resistance to side loads to a maximum of 10% for a longer life span
- The plunger is specially coated with a hardened anodised layer that makes it extremely wear and corrosion resistant
- The XL Saddle optimally protects the plunger and guides the load as effectively as possible
- All cylinders meet the stringent quality requirements that Holmatro enforces for its products

Aluminium versus steel: aluminium cylinders offer an easy to handle alternative to steel. They should last a lifetime of use in average heavy duty lifting applications.

Standard supplied with

- High Flow female coupler A 118
- Flat saddle

Tilting saddles	53
Hydraulic pumps	57
Hydraulic hoses	73
Pressure gauges	76

Additional information

specifications		HAC 20 S 5	HAC 20 S 10	HAC 20 S 15	HAC 30 S 5	HAC 30 S 10	HAC 30 S 15
art no		100.112.267	100.112.265	100.112.261	100.112.269	100.112.268	100.112.262
max. working pressure	bar/Mpa	720 / 72	720 / 72	720 / 72	720 / 72	720 / 72	720 / 72
tonnage	t	20	20	20	30	30	30
stroke	mm	50	100	150	50	100	150
closed height	mm	164	214	264	182	232	282
diameter (B)	mm	82	82	82	106	106	106
capacity	kN/t	204 / 20.8	204 / 20.8	204 / 20.8	318.1 / 32.4	318.1 / 32.4	318.1 / 32.4
effective pressure area	cm ²	28.3	28.3	28.3	44.2	44.2	44.2
required oil content (effective)	cc	141	283	424	221	442	663
connection		A 118	A 118	A 118	A 118	A 118	A 118
cylinder type		standard	standard	standard	standard	standard	standard
acting type		single	single	single	single	single	single
return type		spring	spring	spring	spring	spring	spring
material		aluminium	aluminium	aluminium	aluminium	aluminium	aluminium
weight, ready for use	kg	2.6	3.2	3.9	4.7	5.9	7.0

specifications		HAC 50 S 5	HAC 50 S 10	HAC 50 S 15	HAC 100 S 5	HAC 100 S 10	HAC 100 S 15
art no		100.112.271	100.112.270	100.112.263	100.112.273	100.112.272	100.112.264
max. working pressure	bar/Mpa	720 / 72	720 / 72	720 / 72	720 / 72	720 / 72	720 / 72
tonnage	t	50	50	50	100	100	100
stroke	mm	50	100	150	50	100	150
closed height	mm	183	233	283	225	275	325
diameter (B)	mm	130	130	130	189	189	189
capacity	kN/t	510.4 / 52	510.4 / 52	510.4 / 52	1030.6 / 105.1	1030.6 / 105.1	1030.6 / 105.1
effective pressure area	cm ²	70.9	70.9	70.9	143	143	143
required oil content (effective)	cc	354	709	1063	716	1431	2147
connection		A 118	A 118	A 118	A 118	A 118	A 118
cylinder type		standard	standard	standard	standard	standard	standard
acting type		single	single	single	single	single	single
return type		spring	spring	spring	spring	spring	spring
material		aluminium	aluminium	aluminium	aluminium	aluminium	aluminium
weight, ready for use	kg	6.9	8.3	9.6	17.8	20.9	24.1



ALUMINIUM CYLINDERS | hydraulic return



Features & benefits

- 50% lighter cylinders; easy to work with and better for the welfare of the user
- Duo Power Ring; seal, bearings and resistance to side loads to a maximum of 10% for a longer life span
- The plunger is specially coated with a hardened anodised layer that makes it extremely wear and corrosion resistant
- The XL Saddle optimally protects the plunger and guides the load as effectively as possible
- All cylinders meet the stringent quality requirements that Holmatro enforces for its products

Aluminium versus steel: aluminium cylinders offer an easy to handle alternative to steel. They should last a lifetime of use in average heavy duty lifting applications.

Standard supplied with

- High Flow female coupler A 118
- Flat saddle

Tilting saddles	53
Hydraulic pumps	57
Hydraulic hoses	73
Pressure gauges	76

Additional information

specifications		HAC 30 H 5	HAC 30 H 10	HAC 30 H 15	HAC 50 H 5	HAC 50 H 10	HAC 50 H 15
art no		100.122.086	100.122.085	100.122.080	100.122.095	100.122.108	100.122.097
max. working pressure	bar/Mpa	720 / 72	720 / 72	720 / 72	720 / 72	720 / 72	720 / 72
tonnage	t	30	30	30	50	50	50
stroke	mm	50	100	150	50	100	150
closed height	mm	197	247	297	201	251	301
diameter (B)	mm	125	125	125	145	145	145
capacity	kN/t	318.1 / 32.4	318.1 / 32.4	318.1 / 32.4	510.4 / 52	510.4 / 52	510.4 / 52
effective pressure area (press)	cm ²	44.2	44.2	44.2	70.9	70.9	70.9
effective pressure area (retract)	cm ²	11	11	11	32.4	32.4	32.4
required oil content (press)	cc	221	442	663	354	709	1063
required oil content (retract)	cc	55	110	165	162	324	486
connection		A 118	A 118	A 118	A 118	A 118	A 118
cylinder type		standard	standard	standard	standard	standard	standard
acting type		double	double	double	double	double	double
return type		hydraulic	hydraulic	hydraulic	hydraulic	hydraulic	hydraulic
material		aluminium	aluminium	aluminium	aluminium	aluminium	aluminium
weight, ready for use	kg	6.9	8.5	10.2	9.5	11.5	13.3

specifications		HAC 100 H 5	HAC 100 H 10	HAC 100 H 15	HAC 150 H 5	HAC 150 H 10	HAC 150 H 15
art no		100.122.094	100.122.109	100.122.107	100.122.075	100.122.074	100.122.073
max. working pressure	bar/Mpa	720 / 72	720 / 72	720 / 72	720 / 72	720 / 72	720 / 72
tonnage	t	100	100	100	150	150	150
stroke	mm	50	100	150	50	100	150
closed height	mm	246	296	346	248	298	348
diameter (B)	mm	195	195	195	235	235	235
capacity	kN/t	1030.6 / 105.1	1030.6 / 105.1	1030.6 / 105.1	1539.5 / 157	1539.5 / 157	1539.5 / 157
effective pressure area (press)	cm ²	143.1	143.1	143.1	213.8	213.8	213.8
effective pressure area (retract)	cm ²	56.5	56.5	56.5	91.1	91.1	91.1
required oil content (press)	cc	716	1431	2147	1069	2138	3207
required oil content (retract)	cc	283	565	848	456	911	1367
connection		A 118	A 118	A 118	A 118	A 118	A 118
cylinder type		standard	standard	standard	standard	standard	standard
acting type		double	double	double	double	double	double
return type		hydraulic	hydraulic	hydraulic	hydraulic	hydraulic	hydraulic
material		aluminium	aluminium	aluminium	aluminium	aluminium	aluminium
weight, ready for use	kg	19.7	23.0	26.9	27.7	32.3	38.0

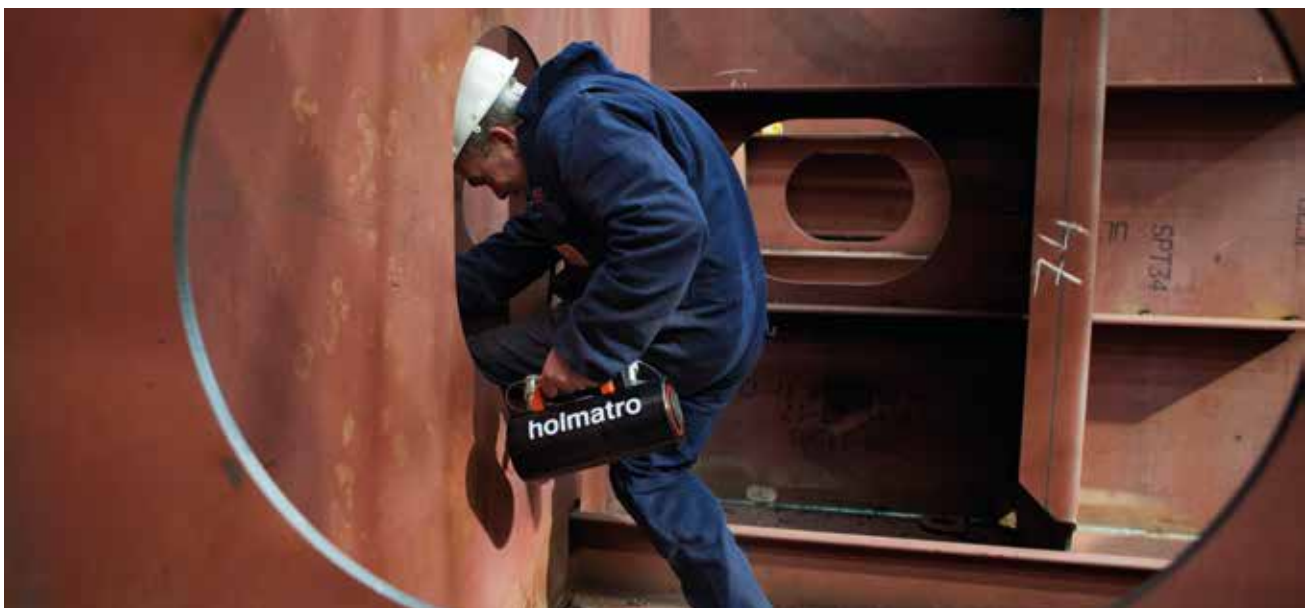

HIGH TONNAGE CYLINDERS | gravity return



Features & benefits

- Usable in all positions
- Protected against ejection of the plunger
- Flat saddle
 - Prevents damage to the plunger
 - Easy to replace with tilting saddle

Tilting saddles	53
Hydraulic pumps	57
Hydraulic hoses	73
Pressure gauges	76

Standard supplied with

- High Flow female coupler A 118
- Flat saddle

specifications		HJ 50 G 6	HJ 50 G 15	HJ 50 G 30	HJ 100 G 6	HJ 100 G 15	HJ 100 G 30
art no		100.112.073	100.112.035	100.112.036	100.112.093	100.112.039	100.112.040
max. working pressure	bar/Mpa	720 / 72	720 / 72	720 / 72	720 / 72	720 / 72	720 / 72
tonnage	t	50	50	50	100	100	100
stroke	mm	60	150	300	60	150	300
closed height	mm	142	282	463	158	309	497
diameter (B)	mm	130	130	130	185	178	178
capacity	kN/t	510.3 / 52	510.3 / 52	510.3 / 52	1029.3 / 105	1029.3 / 105	1029.3 / 105
effective pressure area	cm ²	70.9	70.9	70.9	143	143	143
required oil content (effective)	cc	425	1064	2127	860	2145	4290
connection		A 118	A 118	A 118	A 118	A 118	A 118
cylinder type		high tonnage	high tonnage	high tonnage	high tonnage	high tonnage	high tonnage
acting type		single	single	single	single	single	single
return type		gravity	gravity	gravity	gravity	gravity	gravity
material		steel	steel	steel	steel	steel	steel
weight, ready for use	kg	12.5	27.0	39.5	29.0	51.0	82.0

specifications		HJ 150 G 15	HJ 150 G 30	HJ 200 G 15	HJ 200 G 30	HJ 300 G 15	HJ 300 G 30
art no		100.112.046	100.112.047	100.112.048	100.112.049	100.112.050	100.112.099
max. working pressure	bar/Mpa	720 / 72	720 / 72	720 / 72	720 / 72	720 / 72	720 / 72
tonnage	t	150	150	200	200	300	300
stroke	mm	150	300	150	300	150	300
closed height	mm	317	502	327	507	382	547
diameter (B)	mm	227	227	261	261	316	316
capacity	kN/t	1538.9 / 156.9	1538.9 / 156.9	2040.6 / 208.1	2040.6 / 208.1	2933 / 299.1	2933 / 299.1
effective pressure area	cm ²	213.8	213.8	283.5	283.5	415	415
required oil content (effective)	cc	3207	6414	4253	8505	6225	12450
connection		A 118	A 118	A 118	A 118	A 118	A 118
cylinder type		high tonnage	high tonnage	high tonnage	high tonnage	high tonnage	high tonnage
acting type		single	single	single	single	single	single
return type		gravity	gravity	gravity	gravity	gravity	gravity
material		steel	steel	steel	steel	steel	steel
weight, ready for use	kg	74.6	125.3	120.0	184.0	238.0	257.0



HIGH TONNAGE CYLINDERS | hydraulic return



Features & benefits

- Usable in all positions
- Protected against ejection of the plunger
- Flat saddle
 - Prevents damage to the plunger
 - Easy to replace with tilting saddle

Tilting saddles	53
Hydraulic pumps	57
Hydraulic hoses	73
Pressure gauges	76

Standard supplied with

- High Flow female coupler A 118
- Flat saddle

specifications		HJ 50 H 15	HJ 50 H 30	HJ 100 H 5	HJ 100 H 15	HJ 100 H 30	HJ 150 H 15
art no		100.122.002	100.122.022	100.122.009	100.122.052	100.122.054	100.122.061
max. working pressure	bar/Mpa	720 / 72	720 / 72	720 / 72	720 / 72	720 / 72	720 / 72
tonnage	t	50	50	100	100	100	150
stroke	mm	150	300	50	150	300	150
closed height	mm	282	463	170	309	497	317
diameter (B)	mm	130	130	178	178	178	227
capacity	kN/t	510.3 / 52	510.3 / 52	1029.3 / 105	1029.3 / 105	1029.3 / 105	1538.9 / 156.9
effective pressure area (press)	cm ²	70.9	70.9	143	143	143	213.8
effective pressure area (retract)	cm ²	20.6	20.6	56.6	56.6	56.6	110
required oil content (press)	cc	1064	2127	716	2145	4290	3207
required oil content (retract)	cc	309	620	283	848	1695	1650
connection		A 118	A 118	A 118	A 118	A 118	A 118
cylinder type		high tonnage	high tonnage	high tonnage	high tonnage	high tonnage	high tonnage
acting type		double	double	double	double	double	double
return type		hydraulic	hydraulic	hydraulic	hydraulic	hydraulic	hydraulic
material		steel	steel	steel	steel	steel	steel
weight, ready for use	kg	27.0	44.0	29.0	53.0	85.0	76.0

HIGH TONNAGE CYLINDERS

specifications		HJ 150 H 30	HJ 200 H 15	HJ 200 H 30	HJ 300 H 15	HJ 300 H 30
art no		100.122.062	100.122.071	100.122.072	100.122.084	100.122.083
max. working pressure	bar/Mpa	720 / 72	720 / 72	720 / 72	720 / 72	720 / 72
tonnage	t	150	200	200	300	300
stroke	mm	300	150	300	150	300
closed height	mm	502	327	507	382	547
diameter (B)	mm	227	261	261	316	316
capacity	kN/t	1538.9 / 156.9	2040.6 / 208.1	2040.6 / 208.1	2933 / 299.1	2933 / 299.1
effective pressure area (press)	cm ²	213.8	283.5	283.5	4154.5	415.5
effective pressure area (retract)	cm ²	110	82.5	82.5	131.9	131.9
required oil content (press)	cc	6414	4253	8505	6225	12450
required oil content (retract)	cc	3300	1238	2475	1965	3930
connection		A 118	A 118	A 118	A 118	A 118
cylinder type		high tonnage	high tonnage	high tonnage	high tonnage	high tonnage
acting type		double	double	double	double	double
return type		hydraulic	hydraulic	hydraulic	hydraulic	hydraulic
material		steel	steel	steel	steel	steel
weight, ready for use	kg	128.0	121.0	186.0	240.0	360.0

TELESCOPIC CYLINDERS | gravity return



Features & benefits

- Compact
- Lightweight
- Usable in all positions
- Protected against ejection of the plunger
- 2-stage plunger

Standard supplied with

- High Flow female coupler A 118
- HFJ 10/30 G 4 contains a 30 cm connecting hose with anti-kink spring
- HJ 20/50 G 11 contains a flat saddle

Hydraulic pumps	57
Hydraulic hoses	73
Pressure gauges	76

specifications		HFJ 10/30 G 4	HJ 20/50 G 11
art no		100.111.005	100.112.103
max. working pressure	bar/Mpa	720 / 72	720 / 72
tonnage	t	10	20
stroke	mm	41	111
stroke 1st plunger	mm	21	56
stroke 2nd plunger	mm	20	55
closed height	mm	49	140
diameter (B)	mm	120	125
capacity 1st plunger	kN/t	318 / 32.4	510 / 52
capacity 2nd plunger	kN/t	99.7 / 10.2	203.5 / 20.8
effective pressure area 1st plunger	cm ²	44.2	70.8
effective pressure area 2nd plunger	cm ²	13.9	28.3
required oil content (effective)	cc	118	554
connection		A 118	A 118
hose		yes	
cylinder type		telescopic	telescopic
acting type		single	single
return type		gravity	gravity
material		steel	steel
weight, ready for use	kg	4.5	12.5

LOCKNUT CYLINDERS | gravity return



Features & benefits

- Usable in all positions
- Safe because of mechanical load locking
- Suitable for sustained load
- Flat saddle
 - Prevents damage to the plunger
 - Easy to replace with tilting saddle

Tilting saddles	53
Hydraulic pumps	57
Hydraulic hoses	73
Pressure gauges	76

Standard supplied with

- High Flow female coupler A 118
- Flat saddle

specifications		HJ 50 G 15 SN	HJ 100 G 15 SN	HJ 150 G 15 SN	HJ 250 G 15 SN
art no		100.082.001	100.082.000	100.112.136	100.112.083
max. working pressure	bar/Mpa	720 / 72	720 / 72	720 / 72	720 / 72
tonnage	t	50	100	150	250
stroke	mm	150	150	150	150
closed height	mm	307	323	363	385
diameter (B)	mm	135	190	212	300
capacity	kN/t	510.3 / 52	1029.3 / 105	1538.9 / 159.9	2493.8 / 254.3
effective pressure area	cm ²	70.9	143	213.8	340.6
required oil content (effective)	cc	1065	2150	3207	5195
connection		A 118	A 118	A 118	A 118
cylinder type		lock nut	lock nut	lock nut	lock nut
acting type		single	single	single	single
return type		gravity	gravity	gravity	gravity
material		steel	steel	steel	steel
weight, ready for use	kg	34.0	71.0	101.0	180.0

LOCKNUT CYLINDERS | hydraulic return



Features & benefits

- Extreme low closed height and a maximum side load resistance of 10%.
Therefore useful for many different applications
- Double-acting for controlled lifting and lowering
- Integrated safety valves for protection against overpressure on return side
- Multiple-start and rounded thread on plunger for a quicker positioning of the locknut and easy dirt removal
- Hard chromed cylinder wall for optimal wear resistance and corrosion protection
- QPQ treated mechanical locknut with optimised grip and 4 tommy bar holes for easy locking and unlocking
- XL Saddle+: QPQ tilting saddle protects the plunger and limits eccentric loads
- Cover plate for keeping water and dirt out of the cylinder when it is stored

Standard supplied with

- High Flow female coupler A 118
- Tilting saddle

Hydraulic pumps	57
Hydraulic hoses	73
Pressure gauges	76

specifications		HLC 50 H 5	HLC 50 H 15	HLC 50 H 30	HLC 100 H 5	HLC 100 H 15	HLC 100 H 30
art no		100.122.123	100.122.124	100.122.125	100.122.126	100.122.127	100.122.128
max. working pressure	bar/Mpa	720 / 72	720 / 72	720 / 72	720 / 72	720 / 72	720 / 72
tonnage	t	60	60	60	100	100	100
stroke	mm	50	150	300	50	150	300
closed height	mm	208	327	498	248	370	546
diameter (B)	mm	130	130	130	160	160	160
max. side-load resistance	%	10	10	10	10	10	10
capacity	kN/t	578 / 58.9	578 / 58.9	578 / 58.9	1001 / 102.1	1001 / 102.1	1001 / 102.1
effective pressure area (press)	cm ²	80.3	80.3	80.3	139	139	139
effective pressure area (retract)	cm ²	16.7	16.7	16.7	25.9	25.9	25.9
required oil content (effective)	cc	318	954	1909	566	1696	3391
connection		A 118	A 118	A 118	A 118	A 118	A 118
cylinder type		lock nut	lock nut	lock nut	lock nut	lock nut	lock nut
acting type		double	double	double	double	double	double
return type		hydraulic	hydraulic	hydraulic	hydraulic	hydraulic	hydraulic
material		steel	steel	steel	steel	steel	steel
weight, ready for use	kg	19.5	29.5	44.0	35.0	50.0	72.5

specifications		HLC 150 H 5	HLC 150 H 15	HLC 150 H 30	HLC 250 H 5	HLC 250 H 15	HLC 250 H 30
art no		100.122.129	100.122.130	100.122.131	100.122.132	100.122.133	100.122.134
max. working pressure	bar/Mpa	720 / 72	720 / 72	720 / 72	720 / 72	720 / 72	720 / 72
tonnage	t	150	150	150	250	250	250
stroke	mm	50	150	300	50	150	300
closed height	mm	275	400	580	317	444	625
diameter (B)	mm	194	194	194	245	245	245
max. side-load resistance	%	10	10	10	10	10	10
capacity	kN/t	1544 / 157.4	1544 / 157.4	1544 / 157.4	2586 / 263.7	2586 / 263.7	2586 / 263.7
effective pressure area (press)	cm ²	214.3	214.3	214.3	358.9	358.9	358.9
effective pressure area (retract)	cm ²	37.7	37.7	37.7	75.6	75.6	75.6
required oil content (effective)	cc	883	2649	5299	1417	4251	8502
connection		A 118	A 118	A 118	A 118	A 118	A 118
cylinder type		lock nut	lock nut	lock nut	lock nut	lock nut	lock nut
acting type		double	double	double	double	double	double
return type		hydraulic	hydraulic	hydraulic	hydraulic	hydraulic	hydraulic
material		steel	steel	steel	steel	steel	steel
weight, ready for use	kg	56.3	79.0	112.9	103.0	144.0	203.0



ALUMINIUM HOLLOW PLUNGER CYLINDERS | spring return



Features & benefits

- Up to 60% lighter cylinders compared to steel cylinders - easy to work with and better for the physical welfare of the user
- Compact design and a lower build-in height ensures the product is usable in a variety of applications
- Plunger is coated with a black anodized layer that makes it extremely wear and corrosion resistant
- Hollow saddle
 - Prevents damage to the plunger
 - Also usable for lifting application
- Larger cylinders are equipped with foldable handles for easy carrying and positioning

Hydraulic pumps	57
Hydraulic hoses	73
Pressure gauges	76

Standard supplied with

- High Flow female coupler A 118
- Hollow saddle

specifications		HAHC 20 S 5	HAHC 20 S 10	HAHC 20 S 15	HAHC 20 S 20	HAHC 20 S 25
art no		100.112.366	100.112.367	100.112.368	100.112.369	100.112.370
max. working pressure	bar/Mpa	720 / 72	720 / 72	720 / 72	720 / 72	720 / 72
tonnage	t	20	20	20	20	20
stroke	mm	50	100	150	200	250
closed height	mm	170	240	310	375	429
center hole diameter (R)	mm	27	27	27	27	27
capacity	kN/t	208 / 21.2	208 / 21.2	208 / 21.2	208 / 21.2	208 / 21.2
effective pressure area	cm ²	28.9	28.9	28.9	28.9	28.9
required oil content (effective)	cc	144	288	433	577	721
connection		A 118	A 118	A 118	A 118	A 118
cylinder type		hollow plunger	hollow plunger	hollow plunger	hollow plunger	hollow plunger
acting type		single	single	single	single	single
return type		spring	spring	spring	spring	spring
material		aluminium	aluminium	aluminium	aluminium	aluminium
weight, ready for use	kg	3.4	4.3	5.5	6.3	7.1

ALUMINIUM HOLLOW PLUNGER CYLINDERS

specifications		HAHC 30 S 5	HAHC 30 S 10	HAHC 30 S 15	HAHC 30 S 20	HAHC 30 S 25
art no		100.112.371	100.112.372	100.112.373	100.112.374	100.112.375
max. working pressure	bar/Mpa	720 / 72	720 / 72	720 / 72	720 / 72	720 / 72
tonnage	t	30	30	30	30	30
stroke	mm	50	100	150	200	250
closed height	mm	185	255	325	390	450
center hole diameter (R)	mm	34	34	34	34	34
capacity	kN/t	343 / 35	343 / 35	343 / 35	343 / 35	343 / 35
effective pressure area	cm ²	47.7	47.7	47.7	47.7	47.7
required oil content (effective)	cc	238	477	715	954	1192
connection		A 118	A 118	A 118	A 118	A 118
cylinder type		hollow plunger	hollow plunger	hollow plunger	hollow plunger	hollow plunger
acting type		single	single	single	single	single
return type		spring	spring	spring	spring	spring
material		aluminium	aluminium	aluminium	aluminium	aluminium
weight, ready for use	kg	6.1	7.8	9.5	11.1	12.6

specifications		HAHC 60 S 5	HAHC 60 S 10	HAHC 60 S 15	HAHC 60 S 20	HAHC 60 S 25
art no		100.112.376	100.112.377	100.112.378	100.112.379	100.112.380
max. working pressure	bar/Mpa	720 / 72	720 / 72	720 / 72	720 / 72	720 / 72
tonnage	t	60	60	60	60	60
stroke	mm	50	100	150	200	250
closed height	mm	243	295	363	428	518
center hole diameter (R)	mm	56	56	56	56	56
capacity	kN/t	606 / 61.8	606 / 61.8	606 / 61.8	606 / 61.8	606 / 61.8
effective pressure area	cm ²	84.2	84.2	84.2	84.2	84.2
required oil content (effective)	cc	421	842	1263	1684	2105
connection		A 118	A 118	A 118	A 118	A 118
cylinder type		hollow plunger	hollow plunger	hollow plunger	hollow plunger	hollow plunger
acting type		single	single	single	single	single
return type		spring	spring	spring	spring	spring
material		aluminium	aluminium	aluminium	aluminium	aluminium
weight, ready for use	kg	15.5	18.6	21.8	25.4	29

ALUMINIUM HOLLOW PLUNGER CYLINDERS | hydraulic return



Features & benefits

- Up to 60% lighter cylinders compared to steel cylinders - easy to work with and better for the physical welfare of your employees
- Compact design and a lower build-in height ensures the product is usable in a variety of applications
- Plunger is coated with a black anodized layer that makes it extremely wear and corrosion resistant
- Hollow saddle
 - Prevents damage to the plunger
 - Also usable for lifting application
- Larger cylinders are equipped with foldable handles for easy carrying and positioning

Hydraulic pumps	57
Hydraulic hoses	73
Pressure gauges	76

Standard supplied with

- High Flow female coupler A 118
- Hollow saddle

specifications		HAHC 100 H 5	HAHC 100 H 10	HAHC 100 H 15	HAHC 100 H 20	HAHC 100 H 25
art no		100.112.381	100.112.382	100.112.383	100.112.384	100.112.385
max. working pressure	bar/Mpa	720 / 72	720 / 72	720 / 72	720 / 72	720 / 72
tonnage	t	100	100	100	100	100
stroke	mm	50	100	150	200	250
closed height	mm	229	279	329	379	429
center hole diameter (R)	mm	80	80	80	80	80
capacity (press)	kN/t	1029 / 104.9	1029 / 104.9	1029 / 104.9	1029 / 104.9	1029 / 104.9
capacity (retract)	kN/t	431 / 43.9	431 / 43.9	431 / 49.9	431 / 49.9	431 / 49.9
effective pressure area (press)	cm ²	142.9	142.9	142.9	142.9	142.9
effective pressure area (retract)	cm ²	59.9	59.9	59.9	59.9	59.9
required oil content (press)	cc	715	1429	2144	2859	3574
required oil content (retract)	cc	299	599	898	1198	1497
connection		A 118	A 118	A 118	A 118	A 118
cylinder type		hollow plunger	hollow plunger	hollow plunger	hollow plunger	hollow plunger
acting type		double	double	double	double	double
return type		hydraulic	hydraulic	hydraulic	hydraulic	hydraulic
material		aluminium	aluminium	aluminium	aluminium	aluminium
weight, ready for use	kg	28.2	34	39.7	45.4	51.2

ALUMINIUM HOLLOW PLUNGER CYLINDERS

specifications		HAHC 150 H 5	HAHC 150 H 10	HAHC 150 H 15	HAHC 150 H 20	HAHC 150 H 25
art no		100.112.386	100.112.387	100.112.388	100.112.389	100.112.390
max. working pressure	bar/Mpa	720 / 72	720 / 72	720 / 72	720 / 72	720 / 72
tonnage	t	150	150	150	150	150
stroke	mm	50	100	150	200	250
closed height	mm	247	297	347	397	447
center hole diameter (R)	mm	80	80	80	80	80
capacity (press)	kN/t	1531 / 156.1	1531 / 156.1	1531 / 156.1	1531 / 156.1	1531 / 156.1
capacity (retract)	kN/t	852 / 86.9	852 / 86.9	852 / 86.9	852 / 86.9	852 / 86.9
effective pressure area (press)	cm ²	212.7	212.7	212.7	212.7	212.7
effective pressure area (retract)	cm ²	118,4	118,4	118,4	118,4	118,4
required oil content (press)	cc	1063	2126	3190	4253	5316
required oil content (retract)	cc	592	1184	1776	2368	2960
connection		A 118	A 118	A 118	A 118	A 118
cylinder type		hollow plunger	hollow plunger	hollow plunger	hollow plunger	hollow plunger
acting type		double	double	double	double	double
return type		hydraulic	hydraulic	hydraulic	hydraulic	hydraulic
material		aluminium	aluminium	aluminium	aluminium	aluminium
weight, ready for use	kg	41	48.5	56	63.5	71

HOLLOW PLUNGER CYLINDERS | spring return



Features & benefits

- Compact
- Usable in all positions
- Protected against ejection of the plunger
- Hollow saddle
 - Prevents damage to the plunger

Hydraulic pumps	57
Hydraulic hoses	73
Pressure gauges	76

Standard supplied with

- High Flow female coupler A 118
- Hollow saddle, with the exception of the HHJ 5 S 2.5, HHJ 12 S 5 and HHJ 12 S 15 cylinders

specifications		HHJ 5 S 2.5	HHJ 12 S 5	HHJ 12 S 15	HHJ 17 S 5	HHJ 20 S 5	HHJ 20 S 15
art no		100.111.002	100.111.021	100.111.029	100.112.023	100.112.033	100.112.030
max. working pressure	bar/Mpa	720 / 72	720 / 72	720 / 72	720 / 72	720 / 72	720 / 72
tonnage	t	5	12	12	17	20	20
stroke	mm	25	50	150	50	50	150
closed height	mm	87	156	298	192	182	389
center hole diameter (R)	mm	17	21	21	27	27	27
capacity	kN/t	54.3 / 5.5	126.7 / 12.9	126.7 / 12.9	169.6 / 17.3	223.9 / 22.8	239.9 / 22.8
effective pressure area	cm ²	7.5	17.6	17.6	23.6	31.1	31.1
required oil content (effective)	cc	19	88	264	118	156	467
connection		A 118	A 118	A 118	A 118	A 118	A 118
cylinder type		hollow plunger	hollow plunger	hollow plunger	hollow plunger	hollow plunger	hollow plunger
acting type		single	single	single	single	single	single
return type		spring	spring	spring	spring	spring	spring
material		steel	steel	steel	steel	steel	steel
weight, ready for use	kg	1.9	6.3	11.0	7.3	8.6	18.0

HOLLOW PLUNGER CYLINDERS

specifications		HHJ 30 S 7.5	HHJ 30 S 15	HHJ 45 S 15	HHJ 60 S 7.5	HHJ 110 S 7.5
art no		100.112.055	100.112.034	100.112.061	100.112.081	100.112.101
max. working pressure	bar/Mpa	720 / 72	720 / 72	720 / 72	720 / 72	720 / 72
tonnage	t	30	30	45	60	110
stroke	mm	75	150	150	75	75
closed height	mm	226	362	388	272	315
center hole diameter (R)	mm	33	33	39	45	80
capacity	kN/t	293.7 / 29.9	293.7 / 29.9	453.5 / 46.2	610.4 / 62.2	1107.8 / 113
effective pressure area	cm ²	40.8	40.8	63	84.8	153.9
required oil content (effective)	cc	306	612	945	636	1155
connection		A 118	A 118	A 118	A 118	A 118
cylinder type		hollow plunger	hollow plunger	hollow plunger	hollow plunger	hollow plunger
acting type		single	single	single	single	single
return type		spring	spring	spring	spring	spring
material		steel	steel	steel	steel	steel
weight, ready for use	kg	15.0	25.0	35.5	34.5	78.3



HOLLOW PLUNGER CYLINDERS | hydraulic return



Features & benefits

- Usable in all positions
- Protected against ejection of the plunger
- Protected against overpressure on return side
- Hollow saddle
 - Prevents damage to the plunger

Hydraulic pumps	57
Hydraulic hoses	73
Pressure gauges	76

Standard supplied with

- High Flow female coupler A 118 on inlet port
- High Flow female coupler with pressure relief valve A 418 on outlet port
- Hollow saddle

specifications		HHJ 30 H 15	HHJ 60 H 20	HHJ 100 H 20
art no		100.122.045	100.122.031	100.122.053
max. working pressure	bar/Mpa	720 / 72	720 / 72	720 / 72
tonnage	t	30	60	100
stroke	mm	150	200	200
closed height	mm	285	334	395
center hole diameter (R)	mm	33	45	54
capacity (press)	kN/t	293.7 / 29.9	610.4 / 62.2	1018.5 / 103.9
capacity (retract)	kN/t	131 / 13.4	452.4 / 46.1	706.9 / 72.1
effective pressure area (press)	cm ²	40.8	84.4	141.5
effective pressure area (retract)	cm ²	18.2	62.8	98.2
required oil content (press)	cc	613	1696	2830
required oil content (retract)	cc	274	1256	1964
connection		A 118	A 118	A 118
cylinder type		hollow plunger	hollow plunger	hollow plunger
acting type		double	double	double
return type		hydraulic	hydraulic	hydraulic
material		steel	steel	steel
weight, ready for use	kg	23.0	40.0	78.0

HOLLOW PLUNGER CYLINDERS | gravity return



Features & benefits

- Compact
- Usable in all positions
- Protected against ejection of the plunger

Standard supplied with

- High Flow female coupler A 118

Hydraulic pumps	57
Hydraulic hoses	73
Pressure gauges	76

specifications		HHJ 30 G 5
art no		100.111.053
max. working pressure	bar/Mpa	720 / 72
tonnage	t	30
stroke	mm	50
closed height	mm	120
center hole diameter (R)	mm	33
capacity	kN/t	293.7 / 29.9
effective pressure area	cm ²	40.8
required oil content (effective)	cc	204
connection		A 118
cylinder type		hollow plunger
acting type		single
return type		gravity
material		steel
weight, ready for use	kg	10.0

PULLING CYLINDERS | spring return



Features & benefits

- Compact
- Usable in all positions
- Protected against ejection of the plunger
- Protected against overpressure

Standard supplied with

High Flow female coupler with pressure relief valve A 418

Accessories

- Pulling eyes and clevis eyes (to be ordered separately, 2 pieces per cylinder)
- Protection spring (to be order separately)

Pulling eyes	44
Clevis eyes	44
Protection spring	44
Hydraulic pumps	57
Hydraulic hoses	73
Pressure gauges	76

specifications		HPJ 11 S 15	HPJ 30 S 15	HPJ 60 S 15
art no		100.131.001	100.131.011	100.131.021
max. working pressure	bar/Mpa	720 / 72	720 / 72	720 / 72
tonnage	t	11	30	60
stroke	mm	150	150	150
closed height (A)	mm	320	470	530
capacity	kN/t	113 / 11.5	298.7 / 30.5	610.4 / 62.2
effective pressure area	cm ²	15.7	41.5	84.8
required oil content (effective)	cc	236	623	1272
connection		A 118	A 118	A 118
cylinder type		pulling	pulling	pulling
acting type		single	single	single
return type		spring	spring	spring
material		steel	steel	steel
weight, ready for use	kg	11.5	26.0	45.0

PULLING CYLINDERS | pulling eyes

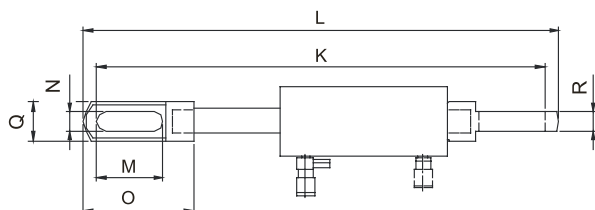

specifications		HPJ 11 S 15	HPJ 30 S 15	HPJ 60 S 15
art no		100.181.051	100.181.051	100.181.052
dimension K	mm	760	890	1000
dimension L	mm	810	940	1080
dimension M	mm	120	120	150
dimension N	mm	35	35	45
dimension O	mm	200	200	260
dimension Q	mm	70	70	115
dimension R	mm	35	35	40

Features & benefits

- Machined from solid steel
- Chemical blacked coating

Additional information

To be ordered separately, 2 pieces per cylinder

PULLING CYLINDERS | clevis eyes

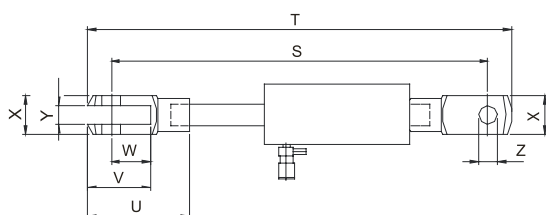

specifications		HPJ 11 S 15	HPJ 30 S 15
art no		100.181.056	100.181.057
dimension S	mm	650	828
dimension T	mm	730	916
dimension U	mm	160	188
dimension V	mm	100	116
dimension W	mm	60	72
dimension X	mm	60	70
dimension Y	mm	30	36
dimension Z	mm	30	35

Features & benefits

- Machined from solid steel
- Complete with pin and quick lock ring
- Specially suitable for use with slings

Additional information

To be ordered separately, 2 pieces per cylinder

PULLING CYLINDERS | protection springs



specifications		HPJ 11/30 S 15	HPJ 60 S 15
art no		100.581.160	100.581.161

Features & benefits

- Protects the plunger against dirt and welding spots

Additional information

To be ordered separately

MACHINE LIFT | spring return

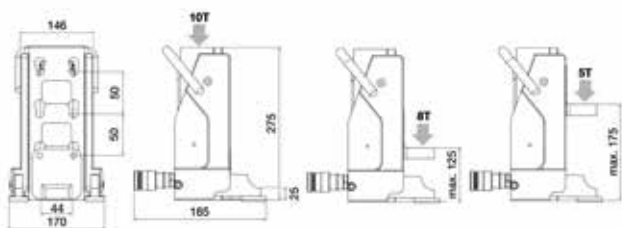

specifications		HMJ 10 S 15 M
art no		100.062.004
max. working pressure	bar/mpa	720 / 72
tonnage	t	10
stroke	mm	145
closed height	mm	275
capacity (head)	kN/t	100 / 10.2
capacity (toe), min.	kN/t	49 / 5
capacity (toe), max.	kN/t	78.5 / 8
required oil content (effective)	cc	208
return type		spring
connection		A 118
weight, ready for use	kg	18.5

Features & benefits

- Toe height adjustable in 3 positions: 25, 100 and 175 mm
- Protected against ejection of the plunger
- Telescopic support legs
- Duplex Power Coating makes the plunger corrosion-resistant
- Duo Power Ring; seal and bearing for long life span

Hydraulic pumps	57
Hydraulic hoses	73
Pressure gauges	76

TOE CYLINDER | spring return

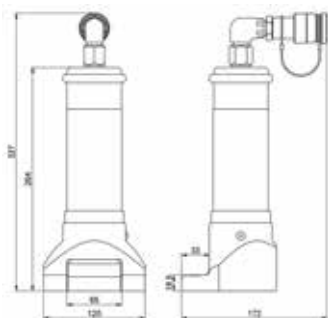

specifications		TJ 8 S 13
art no		100.112.102
max. working pressure	bar/mpa	720 / 72
tonnage	t	8
stroke	mm	130
closed height	mm	319
capacity (toe), min.	kN/t	88.3 / 9
required oil content (effective)	cc	207
return type		spring
connection		A 118
weight, ready for use	kg	6.5

Features & benefits

- Anti-skid profile on the toe
- Usable in all positions
- Compact construction, low weight
- Minimum tip clearance 18.5 mm
- Toe can be rotated 360°

Hydraulic pumps	57
Hydraulic hoses	73
Pressure gauges	76

MULTI PURPOSE CYLINDER | set



Features & benefits

- Consists of:
 - 2x Multi Purpose cylinder, 1x Hydraulic wedge
 - 4x Extension tube
 - 1x Connection socket, 1x Connection nipple
 - 1x Round base plate
 - 1x Cross head, 1x Wedge head
 - 1x Cylinder toe, 1x Plunger toe
 - 1x Plunger adapter, 1x Cylinder body adapter
 - 1x Pump with pressure gauge
 - 1x 2 meter hose with male coupler
 - 1x Storage case











Additional information

ATTENTION: Consult the user manual before fitting cylinder accessories to these cylinders. The maximum working pressure and total construction length is restricted when using cylinder accessories!





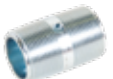





Multi purpose cylinders	17
Parts	47

specifications		HIK 10 M
art no		100.062.003
return type		spring
material		steel
weight, ready for use	kg	44.0
dimension A	mm	782
dimension B	mm	287
dimension C	mm	171









MULTI PURPOSE CYLINDER | set parts









parts	description	model	art no
	High quality Multi Purpose Cylinder. Fitted with unique features that considerably lengthen its life span and service life. Offers appropriate solutions for the most varied applications. Holmatro Multi Purpose Cylinders are available in different capacities and with different stroke lengths.	HGC 10 S 5	100.112.219
	High quality Multi Purpose Cylinder. Fitted with unique features that considerably lengthen its life span and service life. Offers appropriate solutions for the most varied applications. Holmatro Multi Purpose Cylinders are available in different capacities and with different stroke lengths.	HGC 10 S 15	100.112.221
	Hydraulic wedge, spring return <ul style="list-style-type: none"> • To lift a load from a flat surface where there is a minimum insertion space available • Highly suitable to carry out maintenance in places that are difficult to access • Applications: lifting machines, dismantling and assembly, adjustment and alignment 	HW 1000	100.562.009
	Extension tube <ul style="list-style-type: none"> • Suitable for HGC 10 cylinders • Length: 125 mm • Thread size: 1¼" NPT male (2x) • Max. working pressure: 360 bar 	125 - HGC 10	100.002.984
	Extension tube <ul style="list-style-type: none"> • Suitable for HGC 10 cylinders • Length: 250 mm • Thread size: 1¼" NPT male (2x) • Max. working pressure: 360 bar 	250 - HGC 10	100.002.985
	Extension tube <ul style="list-style-type: none"> • Suitable for HGC 10 cylinders • Length: 500 mm • Thread size: 1¼" NPT male (2x) • Max. working pressure: 360 bar 	500 - HGC 10	100.002.987
	Extension tube <ul style="list-style-type: none"> • Suitable for HGC 10 cylinders • Length: 750 mm • Thread size: 1¼" NPT male (2x) • Max. working pressure: 360 bar 	750 - HGC 10	100.002.989
	Connection socket <ul style="list-style-type: none"> • To connect 2 extension tubes • Suitable for HGC 10 cylinders • Thread size: 1¼" NPT female (2x) • Max. working pressure: 360 bar 	HGC 10	100.002.980
	Connection nipple <ul style="list-style-type: none"> • To connect accessories to cylinders • Suitable for HGC 10 cylinders • Thread size: 1¼" NPT male (2x) • Max. working pressure: 360 bar 	HGC 10	100.002.982
	Round base plate <ul style="list-style-type: none"> • To mount on bottom side of cylinder • Suitable for HGC 10 cylinders • Thread size: 1¼" NPT female • Max. working pressure: 360 bar 	HGC 10	100.002.978







MULTI PURPOSE CYLINDERS





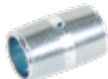

parts	description	model	art no
	<p>Cross head</p> <ul style="list-style-type: none"> • To provide better grip • Suitable for HGC 10 cylinders • Thread size: 1 1/4" NPT female • Max. working pressure: 360 bar 	HGC 10	100.002.966
	<p>Wedge head</p> <ul style="list-style-type: none"> • For spreading • Suitable for HGC 10 cylinders • Thread size: 1 1/4" NPT female • Max. working pressure: 360 bar 	HGC 10	100.002.968
	<p>Cylinder toe</p> <ul style="list-style-type: none"> • Suitable for HGC 10 cylinders • Thread size: 2 1/4"-14 UNS female • Max. working pressure: 144 bar 	HGC 10	100.002.992
	<p>Plunger toe</p> <ul style="list-style-type: none"> • Suitable for HGC 10 cylinders • Thread size: 1 1/4" NPT female • Max. working pressure: 144 bar 	HGC 10	100.002.991
	<p>Cylinder body adapter</p> <ul style="list-style-type: none"> • Suitable for HGC 10 cylinders • Thread size: 1 1/4" NPT female • Max. working pressure: 360 bar • Standard supplied with 2x bolt M8x16 	HGC 10	100.002.969
	<p>Plunger Adapter</p> <ul style="list-style-type: none"> • Suitable for HGC 10 cylinders • Thread size: 1 1/4" NPT male - 1"-8 UNC male • Max. working pressure: 360 bar 	HGC 10	100.002.964
	<p>The PA 04 H 2 is the most compact, single acting, 2 stage hand pump in the hand pump range. The pump is ergonomically designed, has a robust, compact construction, is service- and maintenance-friendly and combines a low operating force with a high oil output. This all combined with a range of handy features makes this pump a worthwhile asset for you and your tools.</p> <p>This pump is ideal when you are working with smaller hydraulic tools and you want to profit from a very high oil output in the first stage (up to 45 bar) to speed things up.</p>	PA 04 H 2	100.142.033
	<p>Standard hose with male coupler A 119 on one side</p>	H 2 SOU	100.572.102
	<p>Pressure gauge set PA 04/09 pump</p> <ul style="list-style-type: none"> • 0-720 bars • Pointer damped with glycerine • Stainless steel • Housing Ø 63 mm • Including rubber protection cover • Connection: 1/4" NPT male 	-	100.182.213
	<p>Carrying storage box of hydraulic jack set HIK 10 M / HRK 10 M</p>	-	150.581.001

ACCESSORIES

5 tons cylinder	description	model	art no
	<p>Aluminium base plate</p> <ul style="list-style-type: none"> • Suitable for HGC 5 and HGC 10 • Max. working pressure: 720 bar • Standard supplied with 2x bolt M8x20 and 2x bolt M6x20 	HGC 5 / 10	100.003.004
	<p>Assembly / Welding Ring</p> <ul style="list-style-type: none"> • Suitable for HGC 5 cylinders • Thread size: 1½"-16 UN • Max. working pressure: 720 bar 	HGC 5	100.182.189
10 tons cylinder	description	model	art no
	<p>Plunger Adapter</p> <ul style="list-style-type: none"> • Suitable for HGC 10 cylinders • Thread size: 1¼" NPT male - 1"-8 UNC male • Max. working pressure: 360 bar 	HGC 10	100.002.964
	<p>Cross head</p> <ul style="list-style-type: none"> • To provide better grip • Suitable for HGC 10 cylinders • Thread size: 1¼" NPT female • Max. working pressure: 360 bar 	HGC 10	100.002.966
	<p>Wedge head</p> <ul style="list-style-type: none"> • For spreading • Suitable for HGC 10 cylinders • Thread size: 1¼" NPT female • Max. working pressure: 360 bar 	HGC 10	100.002.968
	<p>Cylinder body adapter</p> <ul style="list-style-type: none"> • Suitable for HGC 10 cylinders • Thread size: 1¼" NPT female • Max. working pressure: 360 bar • Standard supplied with 2x bolt M8x16 	HGC 10	100.002.969
	<p>Round base plate</p> <ul style="list-style-type: none"> • To mount on bottom side of cylinder • Suitable for HGC 10 cylinders • Thread size: 1¼" NPT female • Max. working pressure: 360 bar 	HGC 10	100.002.978
	<p>Connection socket</p> <ul style="list-style-type: none"> • To connect 2 extension tubes • Suitable for HGC 10 cylinders • Thread size: 1¼" NPT female (2x) • Max. working pressure: 360 bar 	HGC 10	100.002.980
	<p>Connection nipple</p> <ul style="list-style-type: none"> • To connect accessories to cylinders • Suitable for HGC 10 cylinders • Thread size: 1¼" NPT male (2x) • Max. working pressure: 360 bar 	HGC 10	100.002.982

10 tons cylinder	description	model	art no
	<p>Extension tube</p> <ul style="list-style-type: none"> • Suitable for HGC 10 cylinders • Length: 125 mm • Thread size: 1¼" NPT male (2x) • Max. working pressure: 360 bar 	125 - HGC 10	100.002.984
	<p>Extension tube</p> <ul style="list-style-type: none"> • Suitable for HGC 10 cylinders • Length: 250 mm • Thread size: 1¼" NPT male (2x) • Max. working pressure: 360 bar 	250 - HGC 10	100.002.985
	<p>Extension tube</p> <ul style="list-style-type: none"> • Suitable for HGC 10 cylinders • Length: 500 mm • Thread size: 1¼" NPT male (2x) • Max. working pressure: 360 bar 	500 - HGC 10	100.002.987
	<p>Extension tube</p> <ul style="list-style-type: none"> • Suitable for HGC 10 cylinders • Length: 750 mm • Thread size: 1¼" NPT male (2x) • Max. working pressure: 360 bar 	750 - HGC 10	100.002.989
	<p>Aluminium base plate</p> <ul style="list-style-type: none"> • Suitable for HGC 5 and HGC 10 • Max. working pressure: 720 bar • Standard supplied with 2x bolt M8x20 and 2x bolt M6x20 	HGC 5 / 10	100.003.004
	<p>Plunger toe</p> <ul style="list-style-type: none"> • Suitable for HGC 10 cylinders • Thread size: 1¼" NPT female • Max. working pressure: 144 bar 	HGC 10	100.002.991
	<p>Cylinder toe</p> <ul style="list-style-type: none"> • Suitable for HGC 10 cylinders • Thread size: 2¼"-14 UNS female • Max. working pressure: 144 bar 	HGC 10	100.002.992
	<p>Screw-on saddle</p> <ul style="list-style-type: none"> • Suitable for HGC 10 cylinders • Thread size: 1¼" NPT female 	10 D	100.181.091
	<p>Assembly / Welding Ring</p> <ul style="list-style-type: none"> • Suitable for HGC 10 cylinders • Thread size: 2¼"-14 UNS • Max. working pressure: 720 bar 	HGC 10	100.182.190

15 tons cylinder	description	model	art no
	<p>Aluminium base plate</p> <ul style="list-style-type: none"> • Suitable for HGC 15 and HGC 25 • Max. working pressure: 720 bar • Standard supplied with 2x bolt M12x30 and 2x bolt M10x30 	HGC 15 / 25	100.003.005
25 tons cylinder	description	model	art no
	<p>Plunger Adapter</p> <ul style="list-style-type: none"> • Suitable for HGC 25 cylinders • Thread size: 2" NPT male - 1½"-16 UN male • Max. working pressure: 360 bar 	HGC 25	100.002.965
	<p>Cross head</p> <ul style="list-style-type: none"> • To provide better grip • Suitable for HGC 25 cylinders • Thread size: 2" NPT female • Max. working pressure: 360 bar 	HGC 25	100.002.967
	<p>Cylinder body adapter</p> <ul style="list-style-type: none"> • Suitable for HGC 25 cylinders • Thread size: 2" NPT female • Max. working pressure: 360 bar • Standard supplied with 2x bolt M12x20 	HGC 25	100.002.970
	<p>Round base plate</p> <ul style="list-style-type: none"> • To mount on bottom side of cylinder • Suitable for HGC 25 cylinders • Thread size: 2" NPT female • Max. working pressure: 360 bar 	HGC 25	100.002.979
	<p>Connection socket</p> <ul style="list-style-type: none"> • To connect 2 extension tubes • Suitable for HGC 25 cylinders • Thread size: 2" NPT female (2x) • Max. working pressure: 360 bar 	HGC 25	100.002.981
	<p>Connection Nipple</p> <ul style="list-style-type: none"> • To connect accessories to cylinders • Suitable for HGC 25 cylinders • Thread size: 2" NPT male (2x) • Max. working pressure: 360 bar 	HGC 25	100.002.983

25 tons cylinder	description	model	art no
	Extension tube • Suitable for HGC 25 cylinders • Length: 250 mm • Thread size: 2" NPT male (2x) • Max. working pressure: 360 bar	250 - HGC 25	100.002.986
	Extension tube • Suitable for HGC 25 cylinders • Length: 500 mm • Thread size: 2" NPT male (2x) • Max. working pressure: 360 bar	500 - HGC 25	100.002.988
	Extension tube • Suitable for HGC 25 cylinders • Length: 750 mm • Thread size: 2" NPT male (2x) • Max. working pressure: 360 bar	750 - HGC 25	100.002.990
	Aluminium base plate • Suitable for HGC 15 and HGC 25 • Max. working pressure: 720 bar • Standard supplied with 2x bolt M12x30 and 2x bolt M10x30	HGC 15 / 25	100.003.005
	Screw-on saddle • Suitable for HGC 25 cylinders • Thread size: 2" NPT female	24 D	100.181.092
	Assembly / Welding Ring • Suitable for HGC 25 cylinders • Thread size: 3 5/16" - 12 UN • Max. working pressure: 720 bar	HGC 25	100.182.193
50 tons cylinder	description	model	art no
	Assembly / Welding Ring • Suitable for HGC 50 cylinders • Thread size: 5" - 12 UN • Max. working pressure: 720 bar	HGC 50	100.182.194

SADDLES | tilting saddles



Features & benefits

- Prevents side load on the cylinders up to a maximum angle of 5°
- Hardened material

multi purpose cylinders		TS HGC 5	TS HGC 10	TS HGC 15	TS HGC 25	TS HGC 35	TS HGC 50
art no		100.182.151	100.182.152	100.182.153	100.182.154	100.182.155	100.182.156
cylinder tonnage	t	5	10	15	25	35	50
diameter	mm	20	30	30	45	45	70
additional height (vs flat saddle)	mm	5	5	5	7	7	9

multi purpose cylinders		TS HGC 75	TS HGC 100
art no		100.182.160	100.182.150
cylinder tonnage	t	75	100
diameter	mm	70	105
additional height (vs flat saddle)	mm	9	12

aluminium cylinders		TS HAC 20	TS HAC 30	TS HAC 50	TS HAC 100	TS HAC 150
art no		100.182.164	100.182.163	100.182.165	100.182.159	100.182.161
cylinder tonnage	t	20	30	50	100	150
diameter	mm	45	45	70	105	105
additional height (vs flat saddle)	mm	8	8	9	12	12

high tonnage cylinders		S 50 TN	S 100 TN	S 200 TN
art no		100.181.043	100.181.044	100.999.040
cylinder tonnage	t	50	100	200
diameter	mm	65	90	140
additional height (vs flat saddle)	mm	11	11	23

locknut cylinders - gravity		S 50 TN	S 100 TN	S 200 TN
art no		100.181.043	100.181.044	100.999.040
cylinder tonnage	t	50	100	200
diameter	mm	65	90	140
additional height (vs flat saddle)	mm	11	11	23

HAND TOOLS



VERTICAL LIFTING WEDGE | spring return

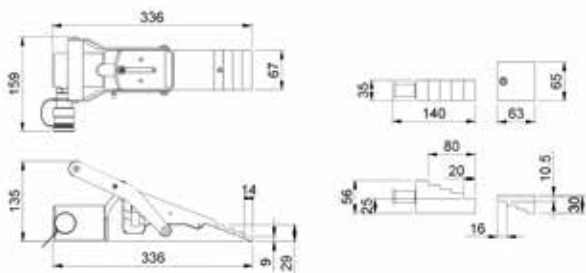

specifications		HVLW 16 S 2
art no		100.112.104
max. working pressure	bar/mpa	720 / 72
tonnage	t	16
min. insertion space	mm	9
lifting stroke	mm	20
max. spreading force	kN/t	156.6 / 16
required oil content (effective)	cc	75
return type		spring
weight, ready for use	kg	8.8

Features & benefits

- 100% vertical lifting movement; prevents misalignment of the load
- Automatic mechanical retraction of lifting plate
- Minimum insertion space of 9 mm
- Vertical lifting stroke of 20 mm at each step

Standard supplied with

- Safety block
- Step block
- Grease pistol
- Grease cartridge Molycote®
- Plastic carrying / storage box

Hydraulic pumps	57
Hydraulic hoses	73
Pressure gauges	76

WEDGE | spring return

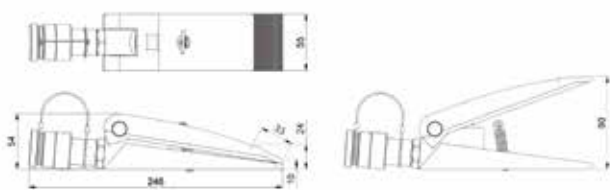

specifications		HW 1000
art no		100.562.009
max. working pressure	bar/mpa	720 / 72
tonnage	t	1
min. insertion space	mm	15
lifting stroke	mm	90
max. spreading force	kN/t	10 / 1
required oil content (effective)	cc	10
return type		spring
weight, ready for use	kg	2.1

Features & benefits

- Compact
- Lightweight
- Anti-skid profile on wedge arms
- Usable in all positions

Hydraulic pumps	57
Hydraulic hoses	73
Pressure gauges	76

WEDGE | hydraulic return

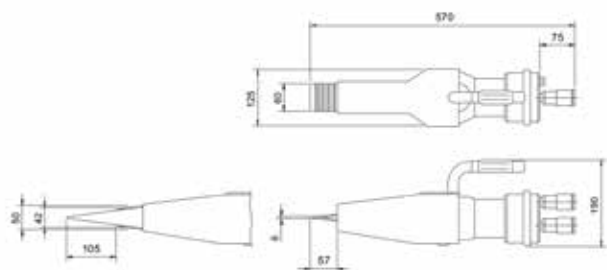

specifications	HWJ 25 U	
art no		100.102.021
max. working pressure	bar/mpa	720 / 72
tonnage	t	24
min. insertion space	mm	6
lifting stroke	mm	51
max. spreading force	kN/t	235.4 / 24
required oil content (press)	cc	328
required oil content (retract)	cc	217
return type		hydraulic
weight, ready for use	kg	8.1

Features & benefits

- Minimum insertion space of 6 mm
- Compact construction
- Low weight
- Anti-skid profile on wedge arms
- Usable in all positions

Hydraulic pumps	57
Hydraulic hoses	73
Pressure gauges	76



HYDRAULIC PUMPS



HAND AND FOOT PUMPS

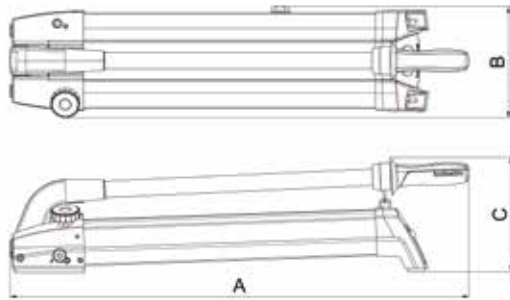

Features & benefits

- Ergonomic design
 - Light weight; easy to carry and operate
 - Low operating force required; minimal user effort
 - Soft-grip handles; more comfort and grip (image 1)
 - Anti-slip rubber underneath; pump is stable and does not shift (image 2)
 - Pump handle lock; easy and safe to carry (image 3)
- Service- and maintenance-friendly; technical parts are easy to access and replace without removing the tank
- High oil output; quicker action both in the first and second stage
- Accurately adjustable pressure release valve; loads can be lowered safely and with extreme control (image 4)
- Pressure gauge connection on the pump block; the pressure gauge can be directly mounted on the pump at an angle of 45 degrees, making it easily readable (image 5)





- Oil level glass in the tank; easily check the oil level in both horizontal and vertical position (image 6)
- Integrated filler funnel; top up oil easily and quickly without extra accessories (image 7)
- Push & Unlock pump handle lock; unlocking is quick and easy with one brief push on the pump handle

Control valves	59
Hydraulic hoses	73
Pressure gauge set	59
FlowPanel™	77

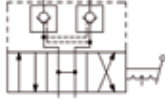

specifications		PA 04 H 2	PA 09 H 2	PA 18 H 2	PA 38 H 2	PA 58 H 2	PA 18 F 2
art no		100.142.033	100.142.034	100.142.035	100.142.037	100.142.038	100.142.036
max. working pressure	bar/Mpa	720 / 72	720 / 72	720 / 72	720 / 72	720 / 72	720 / 72
capacity oil tank (effective)	cc	400	900	1800	3800	5800	1800
capacity oil tank	cc	500	1000	1990	4150	6150	1990
first stage output (per stroke)	cc	18.4	22	42.8	42.8	50.5	42.8
second stage output (per stroke)	cc	1.4	2.1	3.1	3.1	4	3.1
first stage press range	bar/Mpa	0-45 / 0-4.5	0-45 / 0-4.5	0-45 / 0-4.5	0-45 / 0-4.5	0-45 / 0-4.5	0-45 / 0-4.5
second stage pressure range	bar/Mpa	45-720 / 4.5-72	45-720 / 4.5-72	45-720 / 4.5-72	45-720 / 4.5-72	45-720 / 4.5-72	45-720 / 4.5-72
max. operating force	kg	32.0	33.0	35.0	35.0	34.0	37.0
connection		3/8" NPT female	3/8" NPT female	3/8" NPT female	3/8" NPT female	3/8" NPT female	3/8" NPT female
operator type		hand	hand	hand	hand	hand	foot
double acting optional		no	no	yes	yes	yes	yes
weight, ready for use	kg	3.4	4.7	7.6	11.4	14.6	8.3
dimension A	mm	434	619	700	700	897	724
dimension B	mm	135	135	169	183	182	169
dimension C	mm	165	170	175	175	185	167

control valve	hydraulic diagram	description	model	art no
		Control valve <ul style="list-style-type: none"> • Suitable for double-acting tools • Handle stops in each position • With pressure controlled non-return valves for securing the load • 4-way, 3-position • Connection: 3/8" NPT female (2x) • Max. working pressure: 720 bar 	VM 43 L	100.182.175

pressure gauges	description	model	art no
	Pressure gauge set PA 04/09 pump <ul style="list-style-type: none"> • 0-720 bars • Pointer damped with glycerine • Stainless steel • Housing Ø 63 mm • Including rubber protection cover • Connection: 1/4" NPT male 	-	100.182.213
	Pressure gauge set PA *8 pumps <ul style="list-style-type: none"> • 0-720 bars • Pointer damped with glycerine • Stainless steel • Housing Ø 63 mm • Including rubber protection cover • Connection: 1/4" NPT male 	-	100.182.214
	Pressure gauge set PA pumps <ul style="list-style-type: none"> • 0-720 bars • Pointer damped with glycerine • Stainless steel • Housing Ø 100 mm • Including rubber protection cover • Connection: 1x 3/8" NPT female and 1x 3/8" NPT male 	-	100.182.215
	Pressure gauge set VM 43 L valve <ul style="list-style-type: none"> • 0-720 bars • Pointer damped with glycerine • Stainless steel • Housing Ø 63 mm • Including rubber protection cover • Connection: 1/4" NPT male 	-	100.182.216
	Plug-in type gauge set <ul style="list-style-type: none"> • 0-720 bars • Connection: couplers A 118 - A 119 	A 111 U	100.582.111



COMPACT AIR PUMP

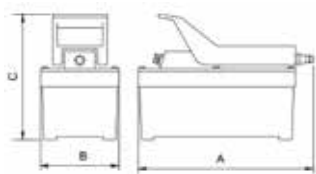

Features & benefits

- Usable at any place because of compact construction
- Lightweight
- Safe; when the air pressure is lost, the oil pressure is maintained
- Spark-free; suitable for explosive rooms
- Low-noise because of built-in silencer
- Energy-saving; stops as soon as the maximum pressure has been reached

Standard supplied with

- Compressed air connector

Additional information

- Unsuitable for lifting applications

Hydraulic hoses	73
Pressure gauges	76
FlowPanel™	77

specifications		AHS 1400 FS
art no		100.602.001
max. working pressure	bar/Mpa	720 / 72
output unloaded	cc/min	960
output loaded	cc/min	410
air consumption unloaded	l/min	700
air consumption loaded	l/min	580
capacity oil tank (effective)	cc	1400
max. air pressure	bar/Mpa	8.5 / 0.8
connection		3/8" NPT female
operator type		air
suitable for (tool type)		single acting
weight, ready for use	kg	6.5
temperature range	°C	-20 + 55
dimension (AxBxC)	mm	282 x 128 x 200

COMPACT ELECTRIC PUMP

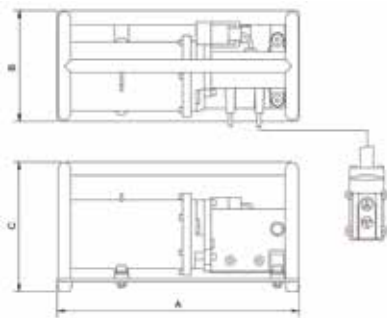

specifications	EHW 1650 RC	
art no		100.551.001
max. working pressure	bar/Mpa	720 / 72
first stage output / min.	cc	2000
second stage output / min.	cc	250
capacity oil tank (effective)	cc	1650
connection		3/8" NPT female
engine		230 VAC - 0.35 kW - 50 Hz - 1 Ph
charge remote control	V	15
weight, ready for use	kg	11.6
dimension (AxBxC)	mm	416 x 190 x 222

Features & benefits

- Usable at any place because of compact construction
- Lightweight
- For both horizontal and vertical use
- Perfectly suitable for cable cutters and nut crackers
- Suitable for single-acting tools and cylinders
- With option 3 the pump is suitable for lifting applications

Standard supplied with

- Waterproof (IP 54) Remote Control with 2.3 m long electric cord

Additional information

- Option 2: Pressure gauge for reading the pressure (art no 100.182.158)
- Option 3: Needle valve and pressure gauge (art no 100.182.162)



VARI PUMPS | configurator

5-step plan for selection of vari pumps

Step 1

Select the power source.

- Electric motor (230 V - 1 ph - 50 Hz)
- Electric motor (400 V - 3 ph - 50 Hz)
- Petrol engine

Step 2

Select pump type.

- 1-stage
- 2-stage for higher operating speed
- Twin, with 2 independant outlets

Step 3

Select the correct content for the oil tank.

Step 4

Select the correct pump output in litres per minute.

Step 5

Select the correct control valve (for twin pumps 2 valves required).

For single-acting tools:

- M 311 (hand operation)

For double-acting tools:

- M 322 (hand operation)
- M 323 (hand operation with deathman's handle)
- M 304 Sada Switch (single acting and double acting in one valve. Only in combination with M322 or M323)
- M 326 (electromagnetic operation)

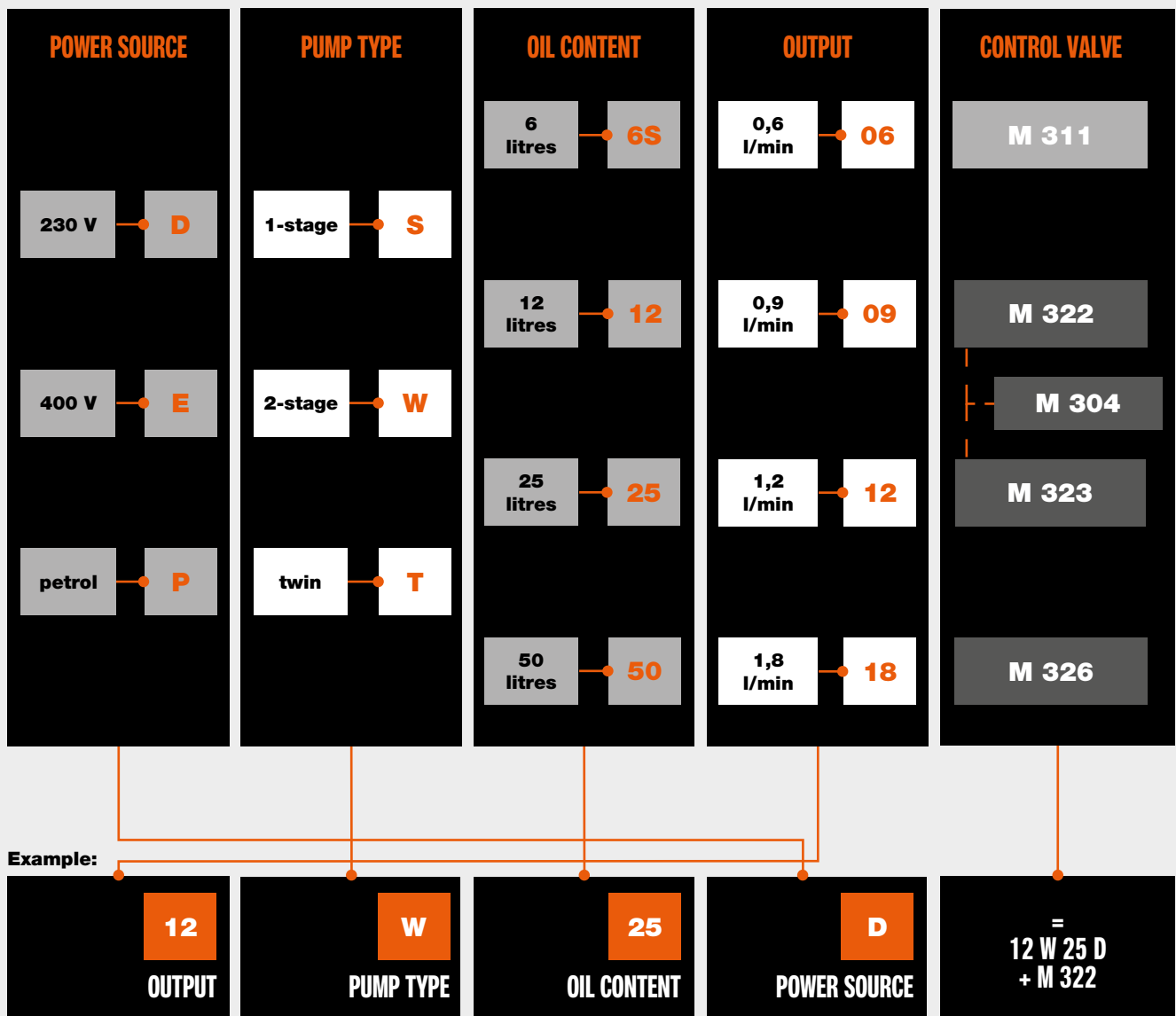

YOU NOW HAVE A FUNCTIONAL PUMP

Do not forget to specify the couplers and/or hoses

Control valves	70
Accessories	71
Hydraulic hoses	73
Pressure gauges	76

VARI PUMPS | 230V - 1-stage



Features & benefits

- Safe
 - In case of a power failure, the oil pressure is maintained
 - Protected against pressure drop by pressure-controlled non-return valve
- Excluding single-acting or double-acting control valve

Control valves	70
Accessories	71
Hydraulic hoses	73
Pressure gauges	76
FlowPanel™	77

specifications		06 S 6 SD	06 S 12 D
art no		100.152.012	100.152.013
max. working pressure	bar/Mpa	720 / 72	720 / 72
capacity oil tank (effective)	cc	6000	12000
first stage output / min.	cc	600	600
first stage pressure range		0-720 / 0-72	0-720 / 0-72
operator type	bar/Mpa	electric motor	electric motor
engine		230 VAC - 1.1 kW - 50 Hz - 1 Ph	230 VAC - 1.1 kW - 50 Hz - 1 Ph
weight, ready for use	kg	36.0	44.0
dimensions (LxWxH)	mm	400 x 300 x 411	400 x 300 x 541

specifications		12 S 6 SD	12 S 12 D
art no		100.152.020	100.152.021
max. working pressure	bar/Mpa	720 / 72	720 / 72
capacity oil tank (effective)	cc	6000	12000
first stage output / min.	cc	1200	1200
first stage pressure range	bar/Mpa	0-720 / 0-72	0-720 / 0-72
operator type		electric motor	electric motor
engine		230 VAC - 1.5 kW - 50 Hz - 1 Ph	230 VAC - 1.5 kW - 50 Hz - 1 Ph
weight, ready for use	kg	38.0	46.0
dimensions (LxWxH)	mm	400 x 300 x 411	400 x 320 x 541

VARI PUMPS | 230V - 2-stage



Features & benefits

- Safe
 - In case of a power failure, the oil pressure is maintained
 - Protected against pressure drop by pressure-controlled non-return valve
- Excluding single-acting or double-acting control valve

Control valves	70
Accessories	71
Hydraulic hoses	73
Pressure gauges	76
FlowPanel™	77

specifications		12 W 6 SD	12 W 25 D	12 W 50 D
art no		100.152.033	100.152.035	100.152.036
max. working pressure	bar/Mpa	720 / 72	720 / 72	720 / 72
capacity oil tank (effective)	cc	6000	25000	50000
first stage output / min.	cc	3200	3200	3200
second stage output / min.	cc	1200	1200	1200
first stage pressure range	bar/Mpa	0-200 / 0-20	0-200 / 0-20	0-200 / 0-20
second stage pressure range	bar/Mpa	200-720 / 0-72	200-720 / 0-72	200-720 / 0-72
operator type		electric motor	electric motor	electric motor
engine		230 VAC - 1.5 kW - 50 Hz - 1 Ph	230 VAC - 1.5 kW - 50 Hz - 1 Ph	230 VAC - 1.5 kW - 50 Hz - 1 Ph
weight, ready for use	kg	40.0	67.0	96.0
dimensions (LxWxH)	mm	400 x 300 x 411	500 x 380 x 541	500 x 380 x 676

VARI PUMPS | 400V - 1-stage



Features & benefits

- Safe
 - In case of a power failure, the oil pressure is maintained
 - Protected against pressure drop by pressure-controlled non-return valve
- Excluding single-acting or double-acting control valve

Control valves	70
Accessories	71
Hydraulic hoses	73
Pressure gauges	76
FlowPanel™	77

specifications		12 S 6 SE	12 S 12 E
art no		100.152.046	100.152.047
max. working pressure	bar/Mpa	720 / 72	720 / 72
capacity oil tank (effective)	cc	6000	12000
first stage output / min.	cc	1200	1200
first stage pressure range	bar/Mpa	0-720 / 0-72	0-720 / 0-72
operator type		electric motor	electric motor
engine		400 VAC - 1.5 kW - 50 Hz - 3 Ph	400 VAC - 1.5 kW - 50 Hz - 3 Ph
weight, ready for use	kg	35.0	43.0
dimensions (LxWxH)	mm	400 x 300 x 441	400 x 300 x 541

specifications		18 S 25 E	18 S 50 E
art no		100.152.051	100.152.052
max. working pressure	bar/Mpa	720 / 72	720 / 72
capacity oil tank (effective)	cc	25000	50000
first stage output / min.	cc	1800	1800
first stage pressure range	bar/Mpa	0-720 / 0-72	0-720 / 0-72
operator type		electric motor	electric motor
engine		400 VAC - 2.2 kW - 50 Hz - 3 Ph	400 VAC - 2.2 kW - 50 Hz - 3 Ph
weight, ready for use	kg	64.0	94.0
dimensions (LxWxH)	mm	500 x 380 x 541	500 x 380 x 676

VARI PUMPS | 400V - 2-stage



Features & benefits

- Safe
 - In case of a power failure, the oil pressure is maintained
 - Protected against pressure drop by pressure-controlled non-return valve
- Excluding single-acting or double-acting control valve

Control valves	70
Accessories	71
Hydraulic hoses	73
Pressure gauges	76
FlowPanel™	77

specifications		12 W 25 E	12 W 50 E
art no		100.152.064	100.152.065
max. working pressure	bar/Mpa	720 / 72	720 / 72
capacity oil tank (effective)	cc	25000	50000
first stage output / min.	cc	3200	3200
second stage output / min.	cc	1200	1200
first stage pressure range	bar/Mpa	0-200 / 0-20	0-200 / 0-20
second stage pressure range	bar/Mpa	200-720 / 0-72	200-720 / 0-72
operator type		electric motor	electric motor
engine		400 VAC - 1.5 kW - 50 Hz - 3 Ph	400 VAC - 1.5 kW - 50 Hz - 3 Ph
weight, ready for use	kg	64.0	94.0
dimensions (LxWxH)	mm	500 x 380 x 541	500 x 380 x 676

specifications		18 W 25 E	18 W 50 E
art no		100.152.067	100.152.068
max. working pressure	bar/Mpa	720 / 72	720 / 72
capacity oil tank (effective)	cc	25000	50000
first stage output / min.	cc	5000	5000
second stage output / min.	cc	1800	1800
first stage pressure range	bar/Mpa	0-200 / 0-20	0-200 / 0-20
second stage pressure range	bar/Mpa	200-720 / 0-72	200-720 / 0-72
operator type		electric motor	electric motor
engine		400 VAC - 2.2 kW - 50 Hz - 3 Ph	400 VAC - 2.2 kW - 50 Hz - 3 Ph
weight, ready for use	kg	96.0	96.0
dimensions (LxWxH)	mm	500 x 380 x 676	500 x 380 x 676

VARI PUMPS | Twin - 400V - 1-stage



Features & benefits

- Pump with 2 separate outlets
- Safe
 - In case of a power failure, the oil pressure is maintained
 - Protected against pressure drop by pressure-controlled non-return valve
- Excluding single-acting or double-acting control valve

Control valves	70
Accessories	71
Hydraulic hoses	73
Pressure gauges	76
FlowPanel™	77

specifications		09 T 12 E	09 T 25 E
art no		100.152.072	100.152.073
max. working pressure	bar/Mpa	720 / 72	720 / 72
capacity oil tank (effective)	cc	12000	25000
first stage output / min.	cc	900	900
first stage pressure range	bar/Mpa	0-720 / 0-72	0-720 / 0-72
operator type		electric motor	electric motor
engine		400 VAC - 2.2 KW - 50 HZ - 3 PH	400 VAC - 2.2 KW - 50 HZ - 3 PH
weight, ready for use	kg	52.0	71.0
dimensions (LxWxH)	mm	400 x 300 x 541	500 x 380 x 541

VARI PUMPS | petrol - 2-stage - 4 stroke



Features & benefits

- Safe
 - In case of a power failure, the oil pressure is maintained
 - Protected against pressure drop by pressure-controlled non-return valve
- Excluding single-acting or double-acting control valve

Control valves	70
Accessories	71
Hydraulic hoses	73
Pressure gauges	76
FlowPanel™	77









EU specifications		12 W 6 SP	18 W 25 P	18 W 50 P
art no		101.002.021	101.002.023	101.002.025
max. working pressure	bar/Mpa	720 / 72	720 / 72	720 / 72
capacity oil tank (effective)	cc	6000	25000	50000
first stage output / min.	cc	3600	5700	5700
second stage output / min.	cc	1300	2000	2000
first stage pressure range	bar/Mpa	0-200 / 0-20	0-200 / 0-20	0-200 / 0-20
second stage pressure range	bar/Mpa	200-720 / 20-72	200-720 / 20-72	200-720 / 20-72
operator type		petrol engine	petrol engine	petrol engine
engine		4 stroke - 4.2 HP - 3.1 kW	4 stroke - 4.2 HP - 3.1 kW	4 stroke - 4.2 HP - 3.1 kW
weight, ready for use	kg	33.0	61.0	91.0
dimensions (LxWxH)	mm	470 x 346 x 472	500 x 400 x 572	500 x 400 x 716

USA specifications		12 W 6 SP	18 W 25 P	18 W 50 P
art no		101.002.026	101.002.030	101.002.028
max. working pressure	bar/Mpa	720 / 72	720 / 72	720 / 72
capacity oil tank (effective)	cc	6000	25000	50000
first stage output / min.	cc	3600	5700	5700
second stage output / min.	cc	1300	2000	2000
first stage pressure range	bar/Mpa	0-200 / 0-20	0-200 / 0-20	0-200 / 0-20
second stage pressure range	bar/Mpa	200-720 / 20-72	200-720 / 20-72	200-720 / 20-72
operator type		petrol engine	petrol engine	petrol engine
engine		4 stroke - 4.2 HP - 3.1 kW	4 stroke - 4.2 HP - 3.1 kW	4 stroke - 4.2 HP - 3.1 kW
weight, ready for use	kg	32.0	60.0	90.0
dimensions (LxWxH)	mm	530 x 370 x 464	554 x 400 x 564	554 x 400 x 700

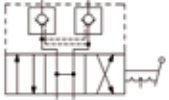

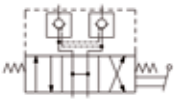

ASIA specifications		12 W 6 SP	18 W 25 P	18 W 50 P
art no		101.002.113	101.002.119	101.002.114
max. working pressure	bar/Mpa	720 / 72	720 / 72	720 / 72
capacity oil tank (effective)	cc	6000	25000	50000
first stage output / min.	cc	3600	5700	5700
second stage output / min.	cc	1300	2000	2000
first stage pressure range	bar/Mpa	0-200 / 0-20	0-200 / 0-20	0-200 / 0-20
second stage pressure range	bar/Mpa	200-720 / 20-72	200-720 / 20-72	200-720 / 20-72
operator type		petrol engine	petrol engine	petrol engine
engine		4 stroke - 4.2 HP - 3.1 kW	4 stroke - 4.2 HP - 3.1 kW	4 stroke - 4.2 HP - 3.1 kW
weight, ready for use	kg	33.0	61.0	91.0
dimensions (LxWxH)	mm	470 x 346 x 472	500 x 400 x 572	500 x 400 x 716



CONTROL VALVES

vari pumps	hydraulic diagram	description	model	art no
		<p>Control Valve</p> <ul style="list-style-type: none"> • Suitable for single-acting tools • Handle stops in each position • 3-way, 3-position • Not in combination with a vari pump model (name) starting with 18 W • Connection 3/8" NPT female thread (2x) • Max. working pressure: 720 bar 	M 311	100.181.311
		<p>Control Valve</p> <ul style="list-style-type: none"> • Suitable for double-acting tools • Handle stops in each position • With pressure-controlled non-return valves for securing the load • 4-way, 3-position • Connection: 3/8" NPT female (2x) • Max. working pressure: 720 bar 	M 322	100.181.322
		<p>Control Valve</p> <ul style="list-style-type: none"> • Suitable for double-acting tools • Handle with dead man's function, automatically goes to "O" position • With pressure-controlled non-return valves for securing the load • 4-way, 3-position • Connection: 3/8" NPT female (2x) • Max. working pressure: 720 bar 	M 323	100.181.323
		<p>Control Valve</p> <ul style="list-style-type: none"> • Only suitable in combination with EC-version Vari pumps. Contact our sales department for additional information • Suitable for double-acting tools. Valve with electromagnetic control (24 VDC) • With non-return valves for securing the load • 3-position, 4-way valve • Connection: 3/8" NPT female (2x) • Remote control, art no 100.151.060 (to be ordered separately). 4 buttons (on, off, lift and lower) • Max. working pressure: 720 bar 	M 326	100.182.321
		<p>Single/double-acting valve</p> <ul style="list-style-type: none"> • For assembly on the vari pump underneath a double-acting valve (M 322, M 323, M326) • This valve makes it possible to drive both single and double acting tools with just one pump • Switch with A + B function (double-acting) or A (single-acting) • Max. working pressure: 720 bar 	M 304	100.172.051

ACCESSORIES

vari pumps	description	model	art no
	<p>Connecting block</p> <ul style="list-style-type: none"> • For mounting couplers or hoses • To be mounted on the pump when using connecting plate M 302 instead of control valve • Provided with pressure relief valve • Connection: 1/4" BSP female (2x), 3/8" NPT female (1x) • Mounting of pressure gauge A 500 possible using nipple 100.581.104 • Mounting pressure gauge A 150 possible using nipple 100.581.128 • Max. working pressure: 720 bar 	M 301 B	100.182.088
	<p>Pressure Control Valve</p> <ul style="list-style-type: none"> • For mounting unto the Pump or unto the connecting plate M 302 (below the connecting block M 301 or below the Valves M 311, M 322, M 323 • Pressure adjustable between 20 and 720 Bars • Max. working pressure: 720 bar 	M 303	100.181.303
	<p>Protection frame for 6, 12, 25 and 50 liter pumps</p>	-	100.151.056
	<p>Cover plate for protection frame</p>	-	100.151.040

SYSTEM COMPONENTS



HYDRAULIC HOSES | single hoses



Features & benefits

- Anti-kink springs on both sides
- 4:1 safety ratio

specifications		H 1 SO	H 2 SO	H 3 SO	H 5 SO	H 10 SO
art no		100.571.101	100.571.102	100.571.103	100.571.105	100.571.110
max. working pressure	bar/Mpa	720 / 72	720 / 72	720 / 72	720 / 72	720 / 72
color		orange	orange	orange	orange	orange
hose connection A		3/8" NPT male	3/8" NPT male	3/8" NPT male	3/8" NPT male	3/8" NPT male
hose connection B		3/8" NPT male	3/8" NPT male	3/8" NPT male	3/8" NPT male	3/8" NPT male
length	m	1	2	3	5	10

HYDRAULIC HOSES | standard hoses



Features & benefits

- Anti-kink springs on both sides
- 4:1 safety ratio

specifications		H 1 SOU	H 2 SOU	H 3 SOU	H 5 SOU	H 10 SOU
art no		100.572.101	100.572.102	100.572.103	100.572.105	100.572.110
max. working pressure	bar/Mpa	720 / 72	720 / 72	720 / 72	720 / 72	720 / 72
color		orange	orange	orange	orange	orange
hose connection A		3/8" NPT male	3/8" NPT male	3/8" NPT male	3/8" NPT male	3/8" NPT male
hose connection B		A 119	A 119	A 119	A 119	A 119
length	m	1	2	3	5	10

HYDRAULIC HOSES | extension hoses













Features & benefits

- Anti-kink springs on both sides
- 4:1 safety ratio





specifications		VL 1 SOU	VL 2 SOU	VL 3 SOU	VL 5 SOU	VL 10 SOU
art no		100.572.301	100.572.302	100.570.294	100.572.305	100.572.310
max. working pressure	bar/Mpa	720 / 72	720 / 72	720 / 72	720 / 72	720 / 72
color		orange	orange	orange	orange	orange
hose connection A		A 119	A 119	A 119	A 119	A 119
hose connection B		A 118	A 118	A 118	A 118	A 118
length	m	1	2	3	5	10

specifications		VL 15 SOU	VL 20 SOU
art no		100.572.315	100.572.320
max. working pressure	bar/Mpa	720 / 72	720 / 72
color		orange	orange
hose connection A		A 119	A 119
hose connection B		A 118	A 118
length	m	15	20



COUPLERS

couplers	description	model	art no
	High Flow Coupler, female, including steel dust cap <ul style="list-style-type: none"> • Connection: 3/8" NPT, male • Fits: A 119 • Max. working pressure: 720 bar 	A 118	100.181.118
	High Flow Coupler, male, including steel dust cap <ul style="list-style-type: none"> • Connection: 3/8" NPT, female • Fits: A 118, A 134 N and A 418 • Max. working pressure: 720 bar 	A 119	100.181.119
	High Flow Coupler, female, like A 118, with built-in pressure relief Valve <ul style="list-style-type: none"> • Adjusted to ca. 750 Bars • Connection: 3/8" NPT, male • Fits: A 119 • Max. working pressure: 720 bar 	A 418	100.181.418
	High flow coupler, female, like A 118, with built-in-non-return valve <ul style="list-style-type: none"> • Suitable for hose rupture security • Not to be used with double-acting systems • Connection: 3/8" NPT, male • Fits: A 119 • Max. working pressure: 720 bar 	A 134 N	100.181.434
	Loose steel dust cap <ul style="list-style-type: none"> • With fixing thread • Fits: A 118 • Max. working pressure: 720 bar 	A 118 SK	100.181.828
	Loose steel dust cap <ul style="list-style-type: none"> • With fixing thread • Fits: A 119 • Max. working pressure: 720 bar 	A 119 SK	100.181.829
	Relief valve <ul style="list-style-type: none"> • For reducing any remnant pressure • Suitable for: A 118 • Max. working pressure: 720 bar 	A 118	100.181.840
	Relief valve <ul style="list-style-type: none"> • For reducing any remnant pressure • Suitable for: A 119 • Max. working pressure: 720 bar 	A 119	100.181.841
	Quick coupler, female, including aluminium dust cap <ul style="list-style-type: none"> • Connection: 1/4" BSP female • Fits: A 239 • Extra lock ring • Max. working pressure: 1000 bar 	A 240	150.581.240
	Quick coupler, male, including aluminium dust cap <ul style="list-style-type: none"> • Connection: 1/4" BSP female • Fits: A 240 • Max. working pressure: 1000 bar 	A 239	150.581.239

PRESSURE GAUGES | scale division in bars

pressure gauges	description	model	art no
	Universal pressure gauge <ul style="list-style-type: none"> • 0 - 720 bars • Pointer damped with glycerine • Stainless steel • Housing Ø 100 mm • Connection: ½" NPT male 	A 500	100.582.500
	Rubber protection cover <ul style="list-style-type: none"> • Suitable for Ø 100 mm pressure gauges 	-	350.581.160
	Pressure gauge <ul style="list-style-type: none"> • 0 - 720 bars • Pointer damped with glycerine • Stainless steel • Housing Ø 60 mm • Connection: ¼" NPT male 	A 150	100.581.036
	Rubber protection cover <ul style="list-style-type: none"> • Suitable for Ø 60 mm pressure gauges 	-	350.581.152
	Pressure gauge digital <ul style="list-style-type: none"> • 0 - 1000 Bars • Peak pressure memory • Connection: ¼" BSP male 	-	150.581.091

PRESSURE GAUGES | adaptors

pressure gauges	description	model	art no
	Pressure gauge connecting block for vari pumps <ul style="list-style-type: none"> • Suitable for single-acting control Valve M 311 • Provided with: 1 x 3/8" NPT female, 1 x 3/8" NPT male and ½" NPT female for pressure gauge • Pressure gauge can be placed in an angle of 45° using Elbow, art no 100.581.240 • Max. working pressure: 720 bar 	A 108	100.181.108
	Pressure gauge connecting block for vari pumps <ul style="list-style-type: none"> • Suitable for double-acting control valves M 322, M 323 and M 324 • Supplies pressure to port A or B, dependent on which is highest • Provided with: 1 x ½" NPT female • Max. working pressure: 720 bar 	M 308	100.182.308

FlowPanel™ | single-acting

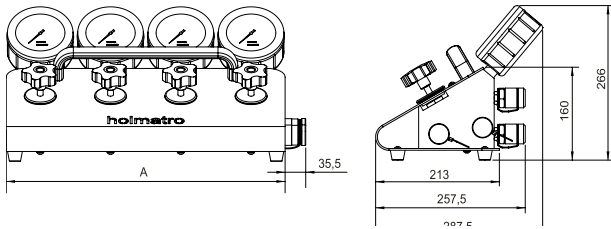

Features & benefits

- Excellent control over your load; extremely accurate regulation of oil flow under high pressure
- Safe; stable construction
- Ergonomic
 - Regulator valves with comfortable rotary knobs
 - Pressure gauges that are easy to read
 - Installation on vari pump is possible for comfortable working position
 - Carry-handle positioned above centre of gravity

Related product:

- Assembly Set FlowPanel™ HMS on Vari Pump (article number: 100.182.111)

Hydraulic hoses	73
Couplers	75
Pressure gauges	76

specifications		HMS 2 C	HMS 4 C	HMS 6 C
art no		100.172.050	100.172.047	100.172.054
max. working pressure	bar/Mpa	720 / 72	720 / 72	720 / 72
number of outlet ports		2	4	6
couplers		yes	yes	yes
pressure gauges		yes	yes	yes
weight, ready for use	kg	9.0	17.8	26.6
dimension A	mm	238	480	722

FlowPanel™ | double-acting

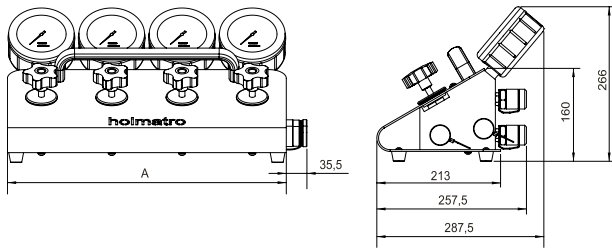

Features & benefits

- Excellent control over your load; extremely accurate regulation of oil flow under high pressure
- Safe; stable construction
- Ergonomic
 - Regulator valves with comfortable rotary knobs
 - Pressure gauges that are easy to read
 - Installation on vari pump is possible for comfortable working position
 - Carry-handle positioned above centre of gravity









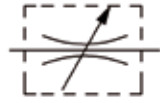

Related product:

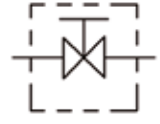
- Assembly Set FlowPanel™ HMD on Vari Pump (article number: 100.182.112)



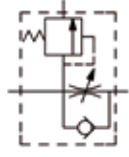







Hydraulic hoses	73
Couplers	75
Pressure gauges	76







specifications		HMD 2 C	HMD 4 C	HMD 6 C
art no		100.172.044	100.172.041	100.172.057
max. working pressure	bar/Mpa	720 / 72	720 / 72	720 / 72
number of outlet ports		2	4	6
couplers		yes	yes	yes
pressure gauges		yes	yes	yes
weight, ready for use	kg	10.0	19.7	29.1
dimension A	mm	238	480	722

VALVES

valves	hydraulic diagram	description	model	art no
		<p>Needle valve A 109 N</p> <ul style="list-style-type: none"> • For accurate control of the oil flow, also under maximum pressure • Connection: 3/8" NPT female (2x) • Max. working pressure: 720 bar 	A 109 N	100.581.609
		<p>Ball valve</p> <ul style="list-style-type: none"> • Very suitable for quick shut-off valve (open-close) • Can be operated under maximum pressure • Connection: 3/8" NPT female (2x) • Max. working pressure: 720 bar 	A 195	100.581.200
		<p>Needle valve A 130</p> <ul style="list-style-type: none"> • For accurate control of the oil flow, also under maximum pressure • Connection: 3/8" NPT male and 3/8" NPT female • Max. working pressure: 720 bar 	A 130	100.181.130
		<p>Breaking safety (load security) valve</p> <ul style="list-style-type: none"> • Protects against sudden pressure drop in the supply pipe, for example in case of hose rupture • To be mounted between pump and cylinder as close to the cylinder as possible • Provided with pressure relief valve, set at 830 bars • While pumping: valve closed, safety valve active • For relief: open valve, safety valve not active • Connection: 3/8" NPT female and 3/8" NPT male • Max. working pressure: 720 bar 	A 110	100.181.110
		<p>High flow coupler, female, like A 118, with built-in-non-return valve</p> <ul style="list-style-type: none"> • Suitable for hose rupture security • Not to be used with double-acting systems • Connection: 3/8" NPT, male • Fits: A 119 • Max. working pressure: 720 bar 	A 134 N	100.181.434
		<p>Non-Return Valve</p> <ul style="list-style-type: none"> • Spring-loaded • Connection: 3/8" NPT male (2x) • Max. working pressure: 720 bar 	A 209	100.581.209

ACCESSORIES HYDRAULICS

accessories hydraulics	description	model	art no
	45° elbow with 1x 1/2" NPT female and 1x 1/2" NPT male • Max. working pressure: 720 bar	-	100.581.240
	Adjustable pin key, complete with 4 pairs of exchangeable pins • Max. working pressure: 720 bar	-	100.581.132
	Cross piece with 4x 3/8" NPT female • Max. working pressure: 720 bar	-	100.581.139
	T-piece with 3x 3/8" NPT female • Max. working pressure: 720 bar	-	100.001.010
	Y-piece with 3x 3/8" NPT female • Max. working pressure: 720 bar	-	100.182.104
	90° Elbow with 1x 3/8" NPT female and 1x 3/8" NPT male • Max. working pressure: 720 bar	-	100.581.113
	90° Elbow with 2x 3/8" NPT male • Max. working pressure: 720 bar	-	100.581.213
	45° Elbow with 1x 3/8" NPT female and 1x 3/8" NPT male • Max. working pressure: 720 bar	-	100.581.114
	90° bend with 1x 1/4" BSP female swivel Nut and 1x 1/4" BSP male • Max. working pressure: 720 bar	-	150.581.219
	Straight tube connector for 12 mm tube with 3/8" NPT male • Max. working pressure: 720 bar	-	100.581.136

accessories hydraulics	description	model	art no
	90° pipe connector for 12 mm tube with 3/8" NPT male • Max. working pressure: 720 bar	-	100.581.137
	Plug with 3/8" NPT • Max. working pressure: 720 bar	-	100.581.105
	Sealing ring for M12 • Max. working pressure: 720 bar	-	190.593.275
	Sealing ring for 1/4" BSP • Max. working pressure: 720 bar	-	150.581.230
	Sealing ring for M14 • Max. working pressure: 720 bar	-	190.593.075
	Sealing ring for M18 • Max. working pressure: 720 bar	-	100.581.158
	Manifold with 5 interconnected ports with 3/8" NPT female • Max. working pressure: 720 bar	A 125	100.181.125

ASSEMBLY MATERIALS | connection socket

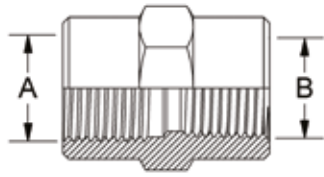

specifications		connection socket	connection socket	connection socket	connection socket	connection socket
art no		100.581.238	150.581.228	100.181.227	100.581.102	100.181.228
max. working pressure	bar/Mpa	720 / 72	720 / 72	720 / 72	720 / 72	720 / 72
thread A		1/4" NPT	1/4" NPT	1/4" BSP	3/8" NPT	3/8" NPT
thread B		1/4" NPT	1/4" BSP	M18 x 1.5	3/8" NPT	M18 x 1.5

ASSEMBLY MATERIALS | reducing bushing

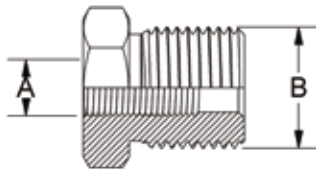

specifications		reducing bushing	reducing bushing	reducing bushing	reducing bushing
art no		100.581.128	150.581.085	100.581.103	100.581.133
max. working pressure	bar/Mpa	720 / 72	720 / 72	720 / 72	720 / 72
thread A		1/4" NPT	1/8" BSP	3/8" NPT	3/8" NPT
thread B		3/8" NPT	1/2" BSP	1/2" NPT	3/4" NPT



ASSEMBLY MATERIALS | nipple

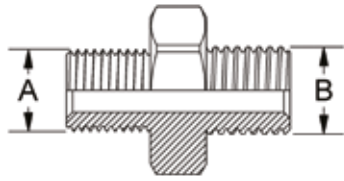

specifications	nipple	nipple	nipple	nipple	nipple	nipple
art no	110.013.004	100.581.239	150.581.244	150.581.227	150.581.218	110.013.044
max. working pressure	bar/Mpa	720 / 72	720 / 72	720 / 72	720 / 72	720 / 72
thread A	1/8" NPT	1/4" NPT	1/4" NPT	1/4" NPT	1/4" BSP	1/4" BSP
thread B	3/8" NPT	1/4" NPT	3/8" NPT	1/4" BSP	3/8" NPT	M12 x 1.75

specifications	nipple	nipple	nipple	nipple	nipple	nipple
art no	150.581.216	100.581.211	100.181.156	110.013.005	100.581.101	100.181.151
max. working pressure	bar/Mpa	720 / 72	720 / 72	720 / 72	720 / 72	720 / 72
thread A	1/4" BSP	1/4" BSP	1/4" BSP	1/4" BSP	3/8" NPT	3/8" NPT
thread B	1/4" BSP	M14 x 1.5	M14 x 2	M10 x 1	3/8" NPT	M14 x 2

specifications	nipple	nipple
art no	150.581.087	150.581.088
max. working pressure	bar/Mpa	720 / 72
thread A	1/2" BSP	1/2" BSP
thread B	3/8" NPT	1/2" NPT

ASSEMBLY MATERIALS | connector

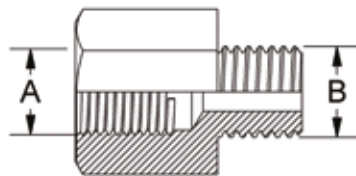







specifications	connector	connector	connector	connector	connector	connector
art no	100.181.223	150.000.398	100.581.235	100.181.159	100.181.047	150.581.217
max. working pressure	bar/Mpa	720 / 72	720 / 72	720 / 72	720 / 72	720 / 72
thread A	1/4" BSP	1/4" BSP	1/4" BSP	1/4" BSP	1/4" NPT	3/8" NPT
thread B	1/4" NPT	3/8" NPT	3/8" BSP	M14 x 2	M10 x 1	1/4" BSP



specifications	connector	connector	connector	connector	connector	connector
art no	100.581.107	100.181.153	100.581.104	100.181.129	150.581.058	100.181.154
max. working pressure	bar/Mpa	720 / 72	720 / 72	720 / 72	720 / 72	720 / 72
thread A	3/8" NPT	3/8" NPT	1/2" NPT	M14 x 1.5	M14 x 1.5	M18 x 1.5
thread B	1/4" NPT	M14 x 2	3/8" NPT	3/8" NPT	1/4" BSP	3/8" NPT

specifications	connector
art no	100.181.157
max. working pressure	bar/Mpa
thread A	M18 x 1.5
thread B	1/4" BSP

OILS

oils	description	model	art no
	Hydraulic oil ECO Power, DIN 51524.3 HVLP, bottle 1 litre <ul style="list-style-type: none"> • Fully mineral oil • Optimum lubricating properties • Excellent protection against wear and corrosion • Up to 3x longer service life than the leading hydraulic oils • Standard oil for all Holmatro motor pumps 	ISO VG 36 - 1L	180.000.857
	Hydraulic oil ECO Power, DIN 51524.3 HVLP, bottle 5 litres <ul style="list-style-type: none"> • Fully mineral oil • Optimum lubricating properties • Excellent protection against wear and corrosion • Up to 3x longer service life than the leading hydraulic oils • Standard oil for all Holmatro motor pumps 	ISO VG 36 - 5L	180.000.815
	Hydraulic oil ECO Power, DIN 51524.3 HVLP, drum 60 litres <ul style="list-style-type: none"> • Fully mineral oil • Optimum lubricating properties • Excellent protection against wear and corrosion • Up to 3x longer service life than the leading hydraulic oils • Standard oil for all Holmatro motor pumps 	ISO VG 36 - 60L	130.103.025
	Hydraulic oil ECO Power, DIN 51524.3 HVLP, drum 208 litres <ul style="list-style-type: none"> • Fully mineral oil • Optimum lubricating properties • Excellent protection against wear and corrosion • Up to 3x longer service life than the leading hydraulic oils • Standard oil for all Holmatro motor pumps 	ISO VG 36 - 208L	180.001.543
	Hydraulic oil ECO Power, DIN 51524.3 HVLP, bottle 1 litre <ul style="list-style-type: none"> • Fully mineral oil • Optimum lubricating properties • Excellent protection against wear and corrosion • Up to 3x longer service life than the leading hydraulic oils • Standard oil for all Holmatro tools and hand pumps 	ISO VG 15 - 1L	100.581.051
	Hydraulic oil ECO Power, DIN 51524.3 HVLP, bottle of 5 litres <ul style="list-style-type: none"> • Fully mineral oil • Optimum lubricating properties • Excellent protection against wear and corrosion • Up to 3x longer service life than the leading hydraulic oils • Standard oil for all Holmatro tools and hand pumps 	ISO VG 15 - 5L	100.581.055
	Motor oil, API SJ/CH-4, bottle 0.6 litre <ul style="list-style-type: none"> • Very good detergent and dispersant • Optimum protection against wear, corrosion and foam • High and stable viscosity • Low sulphate ash content 	0 W 30	150.581.103

LUBRICANTS

lubricants	description	model	art no
	High-quality Molykote® grease • For metal / metal combinations at slow to fast movements with medium to heavy load • Cartridge 400 g	-	100.581.082
	Teflon lubricating oil Sir John® • High-quality lubricant and maintenance oil • Spray can 400 ml	-	150.581.095



MECHANICAL TOOLS



MECHANICAL JACKS | cast iron



Features & benefits

- Made of cast iron; resistant to continuous heavy operating conditions
- Unique ratchet handle for engagement both wheel and plunger
- Self-locking; for safe working
- Robust; can be used close to welding works and under water
- Low maintenance

Standard supplied with

- Handle bar

Traversing beds	88
Base plates	49

specifications		JJ 1015	JJ 1513	JJ 2513	JJ 3513	JJ 5013
art no		200.401.001	200.401.011	200.401.021	200.401.031	200.401.041
tonnage	t	10	15	25	35	50
stroke	mm	150	125	125	130	130
closed height	mm	280	255	255	280	290
capacity	kN/t	98.1 / 10	147.2 / 15	245.3 / 25	343.4 / 35	490.5 / 50
weight, ready for use	kg	12.0	12.0	16.0	24.0	31.0

MECHANICAL PULLING JACK

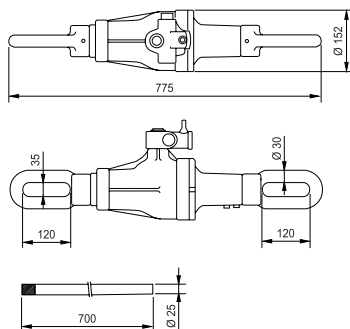

specifications		PL 2510
art no		200.421.001
tonnage	t	25
stroke	mm	100
retracted length	mm	775
capacity	kN/t	245.3 / 25
weight, ready for use	kg	32.0

Features & benefits

- Made of cast iron; resistant to continuous heavy operating conditions
- Unique ratchet handle for engagement both wheel and plunger
- Pulling eyes and a handle bar
- Self-locking; for safe working
- Robust; can be used close to welding works and under water
- Usable in all positions
- Low maintenance

TRAVERSING BED

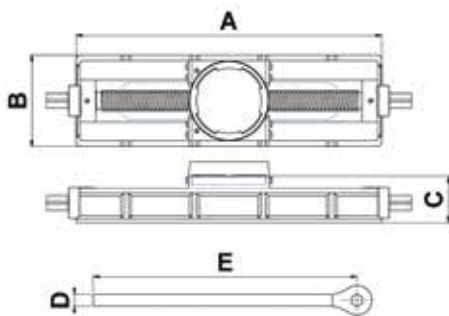

Features & benefits

- Made of cast iron; resistant to continuous heavy operating conditions
- Screw shaft and handle bar; for easy operating
- Self-locking; for safe working
- Robust; can be used close to welding works and under water
- Low maintenance

specifications		TB 5045	TB 2530
art no		200.102.015	200.102.010
suitable for jack		JJ 50**	JJ 25**
max. horizontal displacement	mm	450	300
weight, ready for use	kg	66.0	25.0
dimension A	mm	670	470
dimension B	mm	220	185
dimension C	mm	128	90
dimension D	mm	30	30
dimension E	mm	600	

SHIP WEDGES

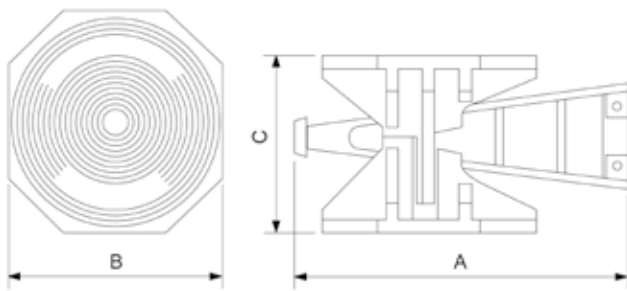

Features & benefits

- Unloads in one go with maximum load
- Robust; resistant to continuous heavy operating conditions
- Can be used close to welding works
- Low maintenance

specifications		W 50	W 80
art no		500.501.050	500.501.080
max. height	mm	225	340
min. height	mm	200	275
capacity	kN/t	490.5 / 50	784.8 / 80
weight, ready for use	kg	29.0	64.5
dimension (AxBxC)	mm	390 x 255 x 200	570 x 345 x 275

HOLMATRO PREMIUM SERVICE CENTERS

Our service network, your benefit!

You wish to service your Holmatro Tools? Find your nearest Holmatro Premium Service Center by scanning the QR code.



'The Holmatro's Premium Service center helps Mennens Groningen to be successful! Not only in selling high-pressure hydraulic tools, but also in being a true, reliable partner for our customers. A big advantage of the Holmatro Premium Service Center is the way how we test; dynamic testing in a controlled environment. This results in a safer way of working for both our employees and customers, leading to more long-term relationships.'

David Posthumus, Director of Mennens Groningen

HOLMATRO TESTTEAM: DO YOU FEEL THE PRESSURE TO WORK SAFE?

Lift a load of 20,000 kg with a cylinder of just 2,6 kg. move a load of 500,000 kg horizontally, or cut a 220kV underground cable with a diameter of 160 mm with a portable cutter. At Holmatro it is all about controlled power. What initially seems unimportant and small, can have far reaching effects due to high pressure hydraulics. Scan the QR code for more safety information.



Be inspired by the Holmatro Testteam

The Holmatro Testteam gives an animated look of working with high pressure hydraulics. Check our Testteam videos on youtube by scanning the QR code.



HOLMATRO INDUSTRIAL EQUIPMENT

Your partner in high-pressure hydraulics

Our DNA

- A Dutch manufacturer of high-pressure hydraulics with +55 years of experience
- Application knowledge is key
- We believe in the power of joint success

Product range

- A reliable and sustainable range of high-quality, high-pressure tools
- Based on innovative, in-house engineering and the latest technologies

Service & Support

- A complete service & aftersales program
- To ensure a longer lifespan of your products
- Reduce downtime
- Focus on increasing safety for your customers and employees and creating safety awareness in the market
- Compatible with current safety directives and regulations
- A "Ready for use" service concept



Thanks to our worldwide partner network there's always a Holmatro partner nearby, ready to assist you!

Find your nearest Holmatro partner on [holmatro.com](https://www.holmatro.com)

Disclaimer - While the greatest care has been devoted to the content, it is possible that the information in this printed matter is incorrect or incomplete. Holmatro B.V. and its affiliated companies (here-after: Holmatro) cannot be held liable in any way for the consequences of activities undertaken based on this printed matter. If you have any doubts about the correctness or completeness of the information, you shall contact Holmatro (phone number: +31 (0)162-751500. Nothing from this printed matter can be copied and/or made public in any way without the explicit authorization of Holmatro.



holmatro.com



Powered by Holmatro



@ByHolmatro



Holmatro Industrial Equipment



Holmatro Industry